

Ersatzteile und Zubehör

für LKW- und Anhängerbeleuchtung

Spare Parts and Accessories

for Trucks and Trailers Lighting





ERSATZTEILE UND ZUBEHÖR

Dieser Katalog enthält die Ersatzteilproduktpalette für Truck & Trailer von Aspöck, welche sich durch hochwertige Qualität und Funktionsicherheit auszeichnet.

Diese Merkmale haben Aspöck zu einem führenden Erstausrüster im Bereich Fahrzeugbeleuchtung gemacht.

SPARE PARTS AND ACCESSORIES

This catalogue contains the spare parts product range for Truck & Trailer by Aspöck, which is characterized through high quality and functional safety.

These features have made Aspöck a leading original equipment manufacturer in the field of vehicle lighting.





Heckleuchte
Rear Lamp



Umrissleuchte
End Outline Marker



Positionsleuchte
Position Lamp

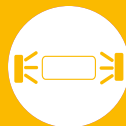

Kennzeichenleuchte
Number Plate Lamp



Bremsleuchte
Stop Lamp



Rückfahrleuchte
Arbeitsscheinwerfer
Reverse Lamp
Working Lamp



Innenleuchte
Interior Lamp



Elektronisches Zubehör
Verbindungselemente
Electronic Accesories
Connection Elements



Information

INHALT / CONTENT

HECKLEUCHTE

REAR LAMP

10	EUROPOINT III	
14	EUROPOINT II	
20	EUROPOINT I	
22	ECOLED	
24	ECOPOINT II	
30	ECOPOINT I	
40	ECOFLEX	
42	EUROFAB	
44	EARPOINT LED	
46	EARPOINT I	
48	MULTILED II	
52	MULTILED	
54	MULTIPOINT V	
56	MULTIPOINT LED	
58	MULTIPOINT I	
60	MINILED II	
62	LINEPOINT II	

64	LINEPOINT I	
66	BRASPOINT 98	
67	BRASPOINT 98	
72	ROUNDPOINT II	
73	ROUNDPOINT II LED	
74	3 CHAMBER LAMP II LED	
77	3 CHAMBER LAMP I LED	
78	3 CHAMBER LAMP	

UMRISSLEUCHTE

END OUTLINE MARKER

84	FLEXIPOINT I	
86	SUPERPOINT IV LED	
88	SUPERPOINT III LED	
92	SUPERPOINT II	

POSITIONSLEUCHTE

POSITION LAMP

98	FLATPOINT II LED	
102	FLATPOINT I LED	
106	UNIPOINT II LED	
108	UNIPOINT I LED	

TECHNISCHE ÄNDERUNGEN UND URHEBERRECHTE VORBEHALTEN.

IN DIESEM KATALOG ANGEFÜHRTE TECHNISCHE DATEN UND LEISTUNGSBESCHREIBUNGEN SIND UNVERBINDLICH. SIE BERUHEN AUF DURCHFÜHRTE TESTS UND ERFAHRUNGSWERTE.

114 SIDEPOINT



118 POSIPOINT II LED



120 POSIPOINT I LED



122 MONOPOINT II LED



126 MONOPOINT I LED



KENNZEICHENLEUCHE

NUMBER PLATE LAMP

130 REGPOINT II LED



132 REGPOINT LED



138 REGPOINT



BREMSLEUCHE

STOP LAMP

142 3. BREMSLEUCHE /
3rd STOP LIGHT



RÜCKFAHRLEUCHE ARBEITSSCHEINWERFER REVERSE LAMP WORKING LAMP

146 RÜCKFAHRSCHEIN-
WERFER /
REVERSE LAMP



148 RÜCKFAHRSCHEIN-
WERFER LED /
REVERSE LAMP LED



150 WORKPOINT LED 3000



152 WORKPOINT LED 1500



154 WORKPOINT LED 800



156 WORKPOINT LED 650



INNENLEUCHE

INTERIOR LAMP

160 INPOINT III LED



162 INTERIOR LAMP
LED ROUND



163 INTERIOR LAMP LED



ELEKTRONISCHES ZUBEHÖR VERBINDUNGSELEMENTE ELECTRONIC ACCESORIES CONNECTION ELEMENTS

166 LCG



168 VERBINDER /
CONNECTORS



ZUSÄTZLICHE INFORMATION

ADDITIONAL INFORMATION

172 E - NUMMERN
ÜBERSICHT



173 APPROVAL NUMBER
OVERVIEW



174 ARTIKELNUMMERN /
PART NUMBERS

XX-XXXX-XXX

178 PIKTOGRAMM
ÜBERSICHT /
PICTOGRAM
OVERVIEW



KONTAKT / CONTACT

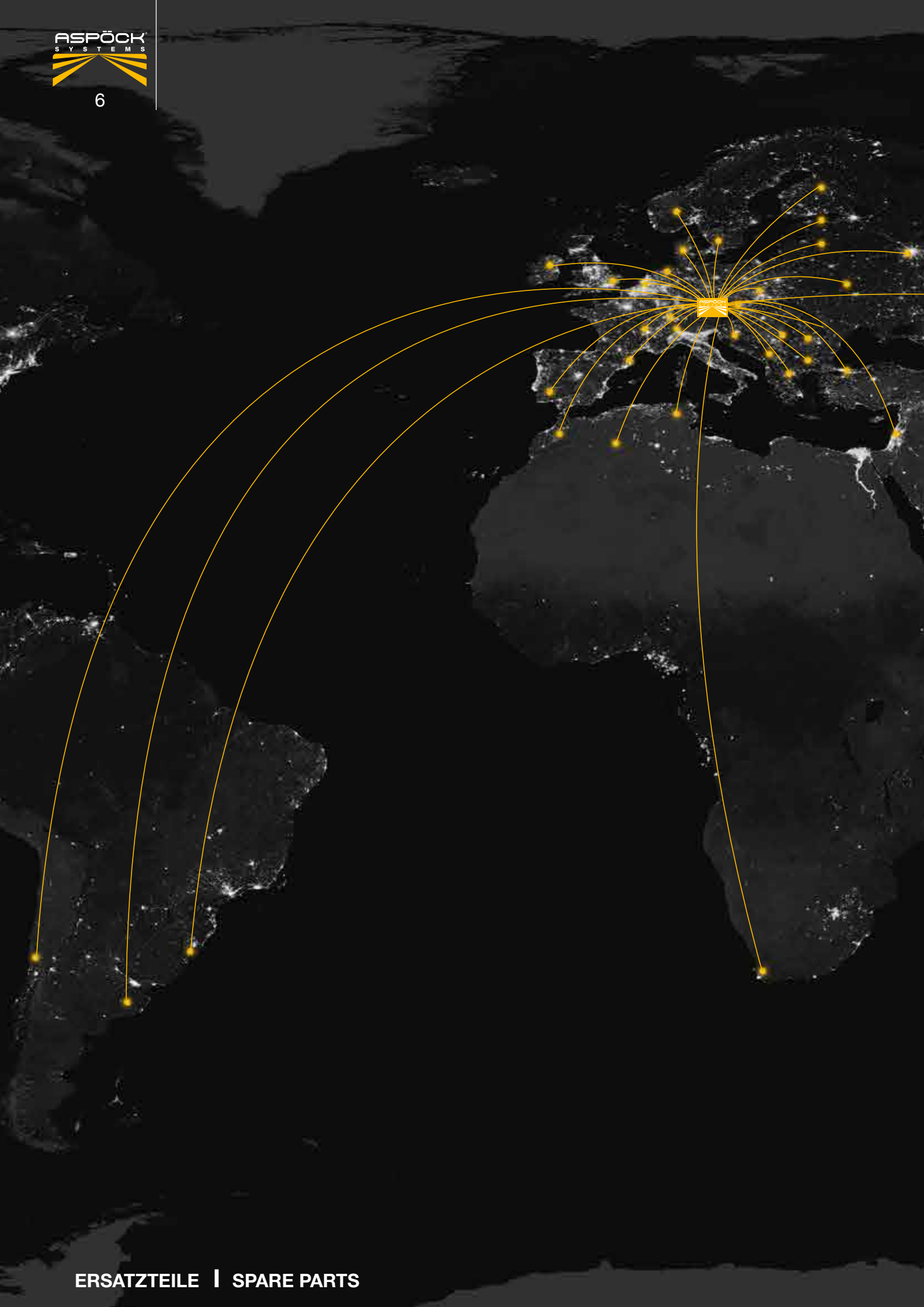

UNTERNEHMEN

Das österreichische Familienunternehmen Aspöck Systems bringt seit 40 Jahren mit der Herstellung von Beleuchtungssystemen das Licht auf die Straße. Dabei stehen seit jeher Qualität und Präzision an vorderster Stelle. Diese Philosophie hat das Unternehmen zum führenden Hersteller vorgefertigter Lichtanlagen für gezogene Fahrzeuge aller Art gemacht.

Der Hauptsitz von Aspöck Systems befindet sich in Peuerbach / Oberösterreich, von wo aus das Unternehmen um weitere Produktionsstätten in Portugal, Polen und Brasilien gewachsen ist. Dazu verteilen sich Vertriebsniederlassungen und Vertriebspartner rund um den Globus und sichern ein weltweites Vertriebs- & Servicenetz.

COMPANY

The Austrian family-run company Aspöck Systems has brought light onto the streets for 40 years now through the manufacture of lighting systems. Here quality and precision have always been of primary importance. This philosophy has made the company the leading manufacturer of preassembled lighting systems for towed vehicles of all kinds.

The headquarter of Aspöck Systems is located in Peuerbach / Upper Austria, from where the company has expanded by further production facilities in Portugal, Poland and Brazil. In addition, sales subsidiaries and sales partners are distributed around the globe to secure a worldwide Sales and Service network.

FÖÖK[®]

T E M S

S



HECKLEUCHE

Das Aspöck Sortiment weist eine große Auswahl an unterschiedlichsten Heckleuchten auf. Je nach Bedarf sind verschiedene Funktionen integriert, welche von Ein-, Zwei- bis Mehrfunktionsleuchten reichen.

REAR LAMP

The Aspöck range features a large selection of very different rear lamps. Dependent on requirements, various functions are integrated which extend from single and dual-function to multifunction lamps.

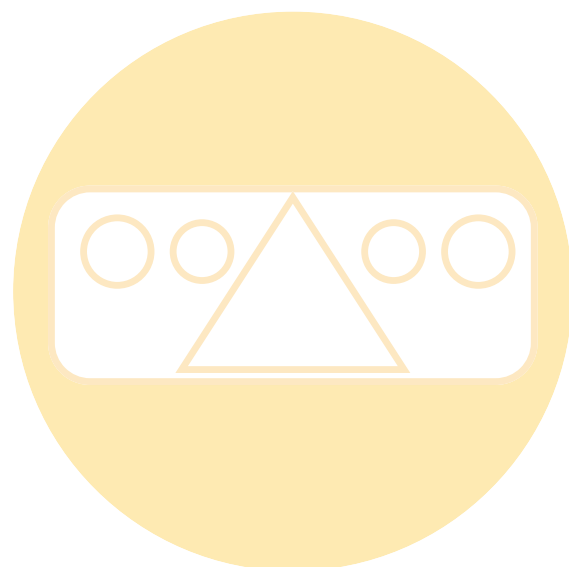



EUROPOINT III

ADR Zone 2 IP56K

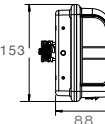
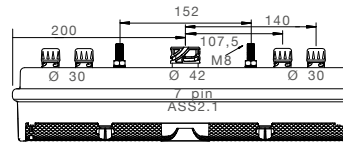
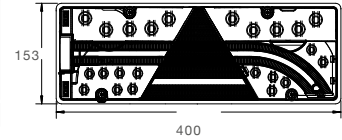
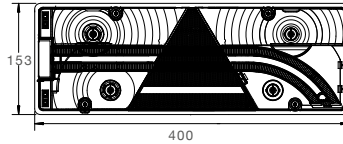

Blinklicht Direction indicator	Rücklicht Tail light	Bremslicht Stop light	Nebelschlusslicht Fog light
Rückfahrlicht Reverse light	Dreieckrückstrahler Triangle reflector	Seitenmarkierungslicht + Reflektor Sidemarker light + reflector	

BEST. NR	PART NO	←	→	LED	V	☀	ZUSATZ	ANSCHLUSS
							ADD ON	CONNECTOR
25-7000-501	1/10	●		LED	24V			7 pol. ASS2.1 7 pin ASS2.1
25-7000-511	1/10	●		LED	24V			7 pol. ASS2.1 7 pin ASS2.1
25-7000-701	1/10	●		LED	24V			7 pol. ASS2.1 7 pin ASS2.1
25-7000-711	1/10	●		LED	24V			7 pol. ASS2.1 7 pin ASS2.1
25-7000-721	1/10	●		LED	24V			7 pol. ASS2.1 7 pin ASS2.1
25-7000-741	1/10	●		LED	24V			7 pol. ASS2.1 7 pin ASS2.1
25-7030-721	1/10	●		LED	24V			7 pol. AMP 7 pin AMP
25-7430-721	1/10		●	LED	24V			7 pol. AMP 7 pin AMP
25-7001-501	1/10	●		LED	24V			7 pol. ASS2.1 7 pin ASS2.1
25-7001-601	1/10	●		LED	24V			7 pol. ASS2.1 7 pin ASS2.1
25-7030-711	1/10	●		LED	24V			7 pol. AMP 7 pin AMP
25-7400-501	1/10		●	LED	24V			7 pol. ASS2.1 7 pin ASS2.1
25-7400-511	1/10		●	LED	24V			7 pol. ASS2.1 7 pin ASS2.1
25-7400-701	1/10		●	LED	24V			7 pol. ASS2.1 7 pin ASS2.1
25-7400-711	1/10		●	LED	24V			7 pol. ASS2.1 7 pin ASS2.1
25-7400-721	1/10		●	LED	24V			7 pol. ASS2.1 7 pin ASS2.1
25-7400-741	1/10		●	LED	24V			7 pol. ASS2.1 7 pin ASS2.1
25-7401-531	1/10		●	LED	24V			7 pol. ASS2.1 7 pin ASS2.1
25-7401-601	1/10		●	LED	24V			7 pol. ASS2.1 7 pin ASS2.1
25-7430-711	1/10		●	LED	24V			7 pol. AMP 7 pin AMP



EUROPOINT III mit Umrissarm
with end outline marker

ADR Zone 2 IP56K

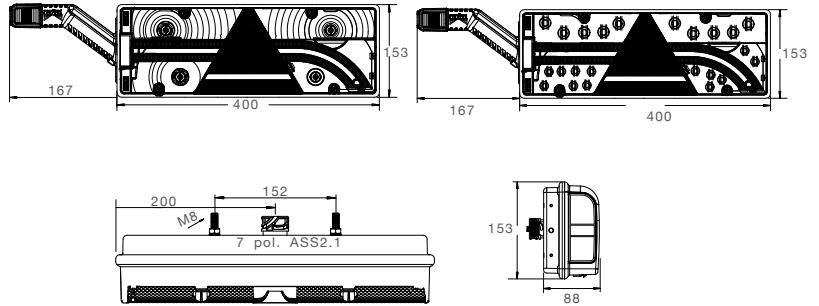

Blinklicht Direction indicator	Rücklicht Tail light	Bremslicht Stop light	Nebelschlusslicht Fog light
Rückfahrlicht Reverse light	Dreieckrückstrahler Triangle reflector	Seitenmarkierungslicht + Reflektor Sidemarker light + reflector	

BEST. NR PART NO							ZUSATZ ADD ON	ANSCHLUSS CONNECTOR
25-7020-501	1/6	●		LED 	24V	LED		7 pol. ASS2.1 7 pin ASS2.1 ♂
25-7020-511	1/6	●		LED 	24V	LED		7 pol. ASS2.1 7 pin ASS2.1 ♂ 4 x 2 pol. ASS2 4 x 2 pin ASS2
25-7020-541	1/6	●		LED 	24V	LED		7 pol. ASS2.1 7 pin ASS2.1 ♂
25-7020-701	1/6	●		LED	24V	LED		7 pol. ASS2.1 7 pin ASS2.1 ♂
25-7020-711	1/6	●		LED	24V	LED		7 pol. ASS2.1 7 pin ASS2.1 ♂ 4 x 2 pol. ASS2 4 x 2 pin ASS2
25-7020-721	1/6	●		LED 	24V	LED		7 pol. ASS2.1 7 pin ASS2.1 ♂
25-7020-731	1/6	●		LED	24V	LED		7 pol. ASS2.1 7 pin ASS2.1 ♂
25-7021-511	1/6	●		LED 	24V	LED		7 pol. ASS2.1 7 pin ASS2.1 ♂ 4 x 2 pol. ASS2 4 x 2 pin ASS2
25-7420-501	1/6		●	LED 	24V	LED		7 pol. ASS2.1 7 pin ASS2.1 ♂
25-7420-511	1/6		●	LED 	24V	LED		7 pol. ASS2.1 7 pin ASS2.1 ♂ 4 x 2 pol. ASS2 4 x 2 pin ASS2
25-7420-541	1/6		●	LED 	24V	LED		7 pol. ASS2.1 7 pin ASS2.1 ♂
25-7420-551	1/6		●	LED 	24V	LED		7 pol. ASS2.1 7 pin ASS2.1 ♂ 4 x 2 pol. ASS2 4 x 2 pin ASS2
25-7420-701	1/6		●	LED	24V	LED		7 pol. ASS2.1 7 pin ASS2.1 ♂
25-7420-711	1/6		●	LED	24V	LED		7 pol. ASS2.1 7 pin ASS2.1 ♂ 4 x 2 pol. ASS2 4 x 2 pin ASS2
25-7420-721	1/6		●	LED 	24V	LED		7 pol. ASS2.1 7 pin ASS2.1 ♂
25-7420-731	1/6		●	LED	24V	LED		7 pol. ASS2.1 7 pin ASS2.1 ♂
25-7420-751	1/6		●	LED	24V	LED		7 pol. ASS2.1 7 pin ASS2.1 ♂ 4 x 2 pol. ASS2 4 x 2 pin ASS2
25-7420-761	1/6		●	LED	24V	LED		7 pol. ASS2.1 7 pin ASS2.1 ♂
25-7421-521	1/6		●	LED 	24V	LED		7 pol. ASS2.1 7 pin ASS2.1 ♂ 4 x 2 pol. ASS2 4 x 2 pin ASS2



EUROPOINT III

ZUBEHÖR / ACCESSORIES

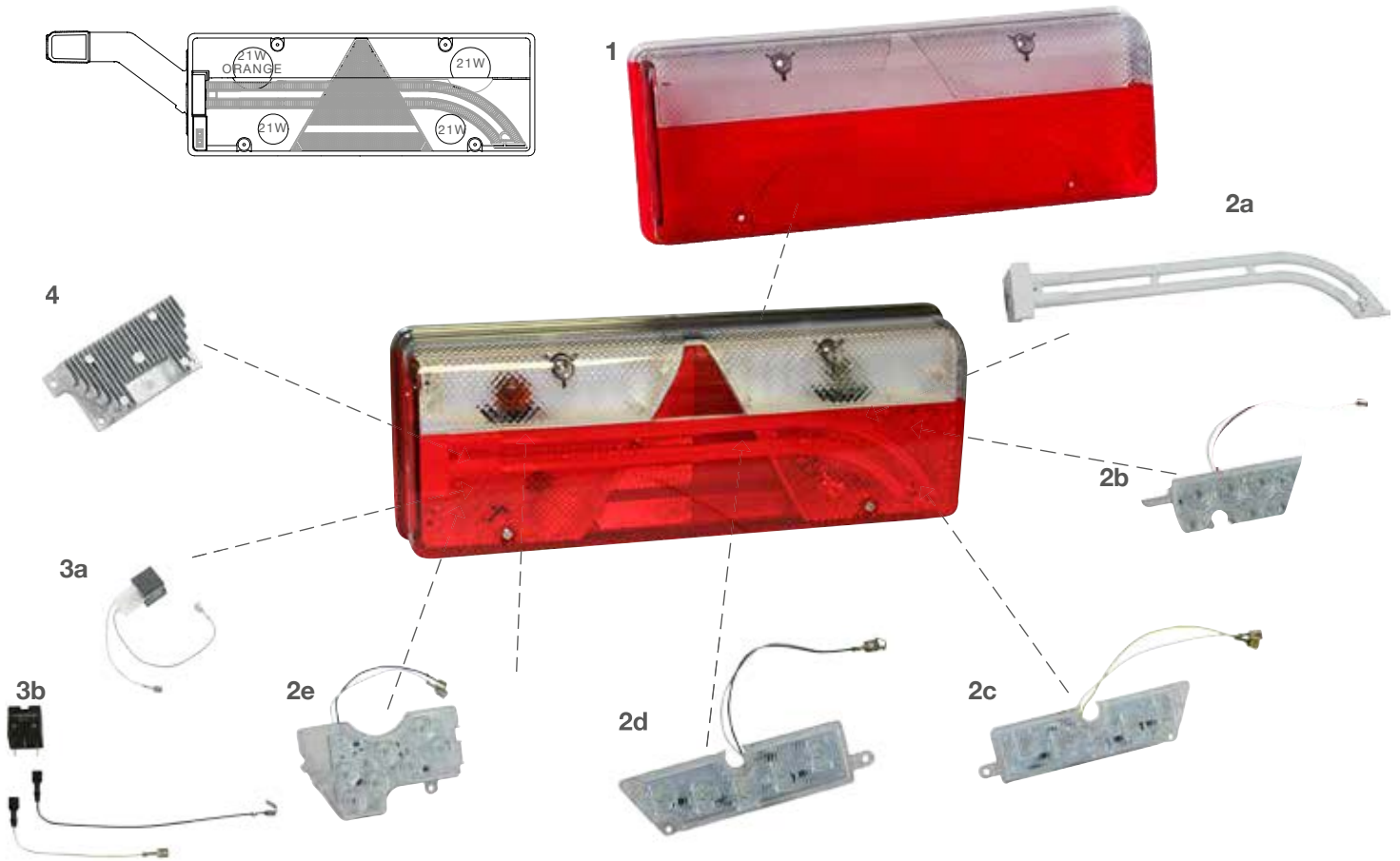

1 Lichtscheibe | lens

- links
- left..... 18-8570-001
- rechts
- right 18-8570-101
- links mit KZL
- left with no. plate lamp 18-8570-011
- rechts mit KZL
- right with no. plate lamp 18-8570-111

2 LED Einsätze | LED inserts

- (a) Rücklicht links („Light Guide“) 12V / 24V
- tail left („Light Guide“) 12V / 24V
- 12-1570-001
- Rücklicht rechts („Light Guide“) 12V / 24V
- tail right („Light Guide“) 12V / 24V
- 12-1570-101
- (b) Bremslicht links 12V / 24V
- stop left 12V / 24V
- 12-1570-204
- Bremslicht rechts 12V / 24V
- stop light right 12V / 24V
- 12-1574-204

- (c) Blinklicht links 24V
- direction indicator left 24V
- 12-1570-224
- Blinklicht rechts 24V
- direction indicator right 24V
- 12-1574-224
- (d) Rückfahrlicht links 24V
- reverse left 24V 12-1570-234
- Rückfahrlicht rechts 24V
- reverse right 24V 12-1574-234
- (e) Nebelschlusslicht links 24V
- fog left 24V 12-1570-214
- Nebelschlusslicht rechts 24V
- fog right 24V 12-1574-214

3 Relais

- (a) Rückfahrwarner 24V
- reverse alarm 24V
- 12-3922-004
- (b) SMCG Steuerung für Seitenmarkierungsleuchten
- SMCG side marker control gear
- 12-3970-584



EUROPOINT III

ZUBEHÖHR / ACCESSORIES

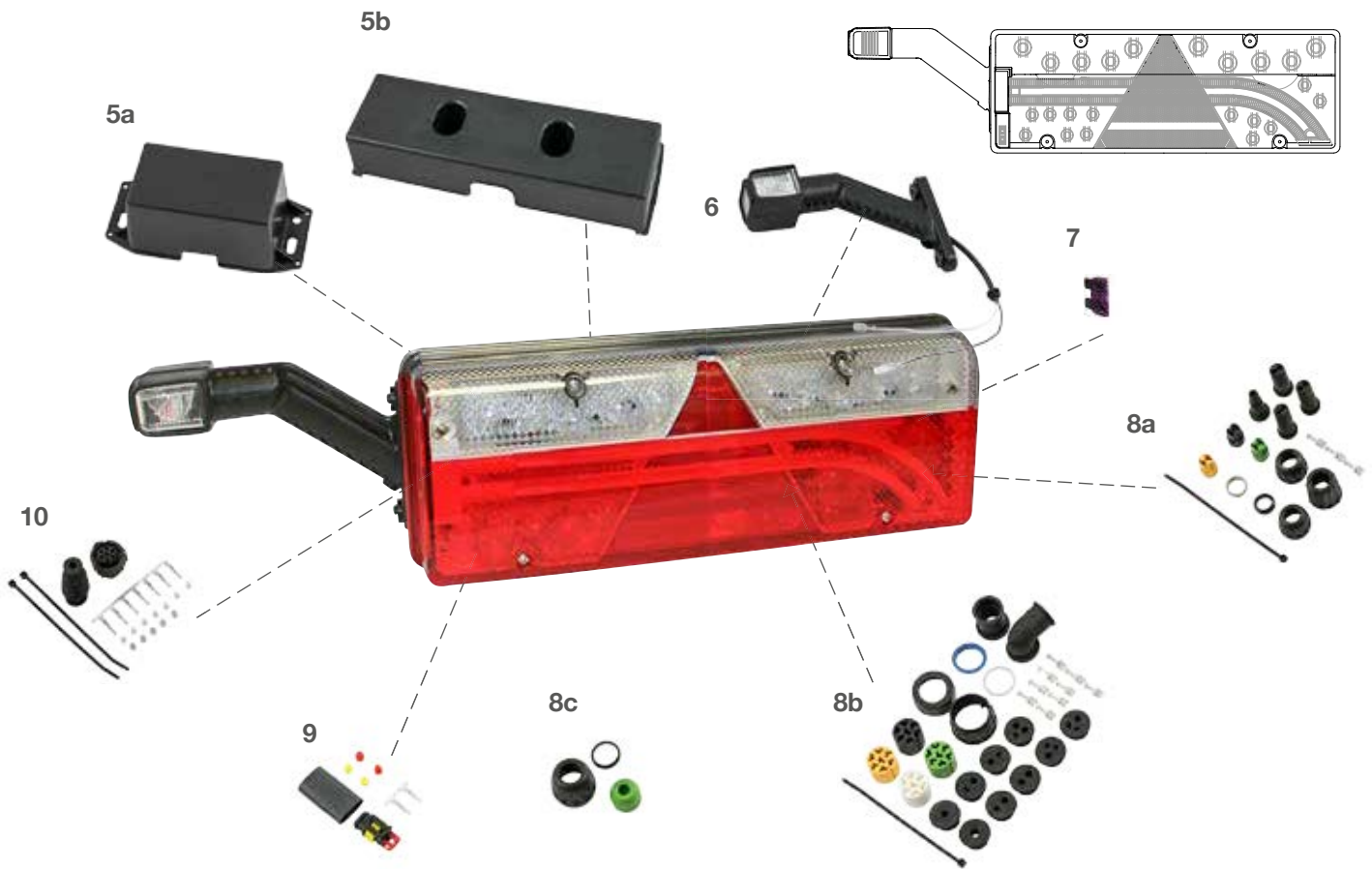

4 LED Vorschaltgerät | LED control gear
 LCG 25-7008-024
 siehe Seite 166
 see at page 166

5 Schutzhaube | protection cap
 (a) klein
 small 15-5270-004
 (b) groß
 big 15-5276-004

6 Umrissarm LED | outline marker LED
 links ^{24V}
 left ^{24V} 31-3103-024
 rechts ^{24V}
 right ^{24V} 31-3102-024

7 Sicherung | fuse
 3 A 12-6830-094

8 ASS1 & ASS2 Verbinder | ASS1 & ASS2 connector
 (a) 2 pol. weiblich
 2 pin female 13-5626-401
 (b) 7 pol. weiblich
 7 pin female 13-5626-631
 (c) Verschlusskappe
 closed connection 15-5623-304

9 Superseal Verbinder | Superseal connector
 2 pol. weiblich
 2 pin female 15-7002-044

10 AMP Verbinder | AMP connector
 7 pol. weiblich
 7 pin female 15-7002-024

Glühlampe | bulb
 24V 21W orange 16-6321-617
 24V 21W 16-6321-037



EUROPOINT II

ADR Zone 2

IP 54

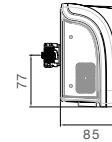
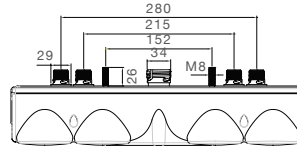
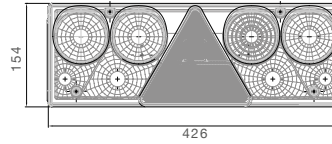

Blinklicht Direction indicator	Rücklicht Tail light	Bremslicht Stop light	Nebelschlusslicht Fog light
Rückfahrlicht Reverse light	Dreieckrückstrahler Triangle reflector	Seitenmarkierungslicht + Reflektor Sidemarker light + reflector	

BEST. NR	PART NO							ZUSATZ ADD ON	ANSCHLUSS CONNECTOR
25-6000-501	1/10	●				24V		7 pol. ASS2 7 pin ASS2	
25-6000-701	1/10	●			LED 	24V		7 pol. ASS2 7 pin ASS2	
25-6000-711	1/10	●			LED 	24V		7 pol. ASS2.1 7 pin ASS 2.1	
25-6000-721	1/10	●			LED 	24V		7 pol. ASS2 7 pin ASS2	
25-6000-741	1/10	●			LED 	24V		7 pol. ASS2 7 pin ASS2	
25-6000-751	1/10	●			LED 	24V		7 pol. ASS2 7 pin ASS2	
25-6001-501	1/10	●				24V		7 pol. ASS2 7 pin ASS2	
25-6010-501	1/10	●			LED 	24V		7 pol. ASS2.1 7 pin ASS2.1	4 x 2 pol. ASS2 4 x 2 pin ASS2
25-6010-541	1/10	●			LED 	24V		7 pol. ASS2 7 pin ASS2	
25-6011-501	1/10	●			LED 	24V		7 pol. ASS2.1 7 pin ASS 2.1	4 x 2 pol. ASS2 4 x 2 pin ASS2
25-6030-501	1/10	●			LED 	24V		7 pol. AMP 7 pin AMP	4 x 2 pol. Superseal 4 x 2 pin Superseal
25-6030-701	1/10	●			LED 	24V		7 pol. AMP 7 pin AMP	4 x 2 pol. Superseal 4 x 2 pin Superseal
25-6030-711	1/10	●				24V		7 pol. AMP 7 pin AMP	4 x 2 pol. Superseal 4 x 2 pin Superseal
25-6101-501	1/10	●				24V		7 pol. ASS2 7 pin ASS2	2 x 2 pol. ASS2 2 x 2 pin ASS2
25-6200-501	1/10	●				24V		7 pol. ASS2 7 pin ASS2	4 x 2 pol. ASS2 4 x 2 pin ASS2
25-6201-511	1/10	●				24V		7 pol. ASS2.1 7 pin ASS 2.1	4 x 2 pol. ASS2 4 x 2 pin ASS2

EUROPOINT II

ADR Zone 2

IP 54

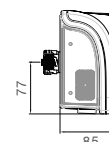
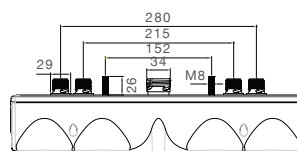
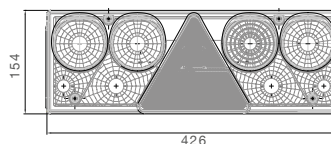

Blinklicht Direction indicator	Rücklicht Tail light	Bremslicht Stop light	Nebelschlusslicht Fog light
Rückfahrlicht Reverse light	Dreieckrückstrahler Triangle reflector	Seitenmarkierungslicht + Reflektor Sidemarker light + reflector	

BEST. NR							ZUSATZ	ANSCHLUSS					
PART NO							ADD ON	CONNECTOR					
25-6400-501	1/10		●		24V			7 pol. ASS2 7 pin ASS2					
25-6400-701	1/10		●		24V			7 pol. ASS2 7 pin ASS2					
25-6400-711	1/10		●		24V			7 pol. ASS2.1 7 pin ASS 2.1					
25-6400-721	1/10		●		24V			7 pol. ASS2 7 pin ASS2					
25-6400-741	1/10		●		24V			7 pol. ASS2 7 pin ASS2					
25-6400-751	1/10		●		24V			7 pol. ASS2 7 pin ASS2					
25-6401-501	1/10		●		24V			7 pol. ASS2 7 pin ASS2					
25-6410-501	1/10		●		24V			7 pol. ASS2.1 7 pin ASS2.1				4 x 2 pol. ASS2 4 x 2 pin ASS2	
25-6410-541	1/10		●		24V			7 pol. ASS2 7 pin ASS2				4 x 2 pol. ASS2 4 x 2 pin ASS2	
25-6411-501	1/10		●		24V			7 pol. ASS2.1 7 pin ASS 2.1				4 x 2 pol. ASS2 4 x 2 pin ASS2	
25-6430-501	1/10		●		24V			7 pol. AMP 7 pin AMP				4 x 2 pol. Superseal 4 x 2 pin Superseal	
25-6430-701	1/10		●		24V			7 pol. AMP 7 pin AMP				4 x 2 pol. Superseal 4 x 2 pin Superseal	
25-6430-711	1/10		●		24V			7 pol. AMP 7 pin AMP				4 x 2 pin Superseal	
25-6501-501	1/10		●		24V			7 pol. ASS2 7 pin ASS2				2 x 2 pol. ASS2 2 x 2 pin ASS2	
25-6501-511	1/10		●		24V			7 pol. ASS2 7 pin ASS2				2 x 2 pol. ASS2 2 x 2 pin ASS2	
25-6600-501	1/10		●		24V			7 pol. ASS2 7 pin ASS2				4 x 2 pol. ASS2 4 x 2 pin ASS2	
25-6601-511	1/10		●		24V			7 pol. ASS2 7 pin ASS2				4 x 2 pol. ASS2 4 x 2 pin ASS2	



EUROPOINT II mit Umrissarm
with end outline marker

ADR
Zone 2

IP 54

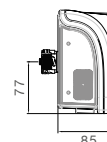
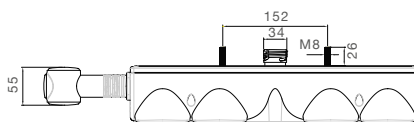
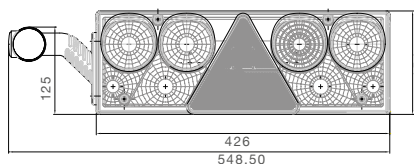

Blinklicht Direction indicator	Rücklicht Tail light	Bremslicht Stop light	Nebelschlusslicht Fog light
Rückfahrlicht Reverse light	Dreieckrückstrahler Triangle reflector	Seitenmarkierungslicht + Reflektor Sidemarker light + reflector	

BEST. NR		←	→				ZUSATZ	ANSCHLUSS	
PART NO							ADD ON	CONNECTOR	
25-6011-511	1/6	●			24V			7 pol. ASS2 7 pin ASS2	♂
25-6011-701	1/6	●			24V			7 pol. ASS2 7 pin ASS2	♂
25-6012-501	1/6	●			24V			7 pol. ASS2 7 pin ASS2	♂
25-6015-501	1/6	●			24V			7 pol. ASS2 7 pin ASS2	♂
25-6020-751	1/6	●			24V			7 pol. ASS2 7 pin ASS2	♂
25-6021-701	1/6	●			24V			7 pol. ASS2 7 pin ASS2	♂
25-6021-731	1/6	●			24V			7 pol. ASS2 7 pin ASS2	♂
25-6021-741	1/6	●			24V			7 pol. ASS2 7 pin ASS2	♂
25-6110-501	1/6	●			24V			7 pol. ASS2 7 pin ASS2	♂ 2 x 2 pol. ASS2 2 x 2 pin ASS2
25-6110-711	1/6	●			24V			7 pol. ASS2 7 pin ASS2	♂ 2 x 2 pol. ASS2 2 x 2 pin ASS2
25-6210-501	1/6	●			24V			7 pol. ASS2 7 pin ASS2	♂ 4 x 2 pol. ASS2 4 x 2 pin ASS2
25-6211-501	1/6	●			24V			7 pol. ASS2 7 pin ASS2	♂ 4 x 2 pol. ASS2 4 x 2 pin ASS2

EUROPOINT II mit Umrissarm
with end outline marker

ADR Zone 2

IP 54

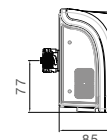
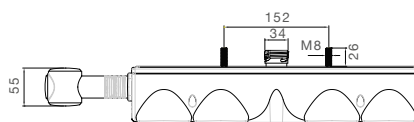
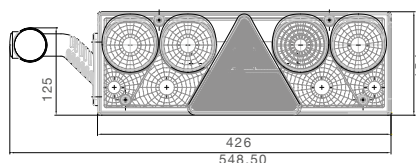

Blinklicht Direction indicator	Rücklicht Tail light	Bremslicht Stop light	Nebelschlusslicht Fog light
Rückfahrlicht Reverse light	Dreieckrückstrahler Triangle reflector	Seitenmarkierungslicht + Reflektor Sidemarker light + reflector	

BEST. NR		←	→	💡	⚡	🔦	ZUSATZ	ANSCHLUSS
PART NO							ADD ON	CONNECTOR
25-6411-511	1/6		●	💡	24V	💡		7 pol. ASS2 7 pin ASS2 ♂
25-6411-701	1/6		●	LED 	24V	💡		7 pol. ASS2 7 pin ASS2 ♂
25-6412-501	1/6		●	💡	24V	💡		7 pol. ASS2 7 pin ASS2 ♂
25-6415-501	1/6		●	💡	24V	💡		7 pol. ASS2 7 pin ASS2 ♂
25-6420-751	1/6		●	LED	24V	LED		7 pol. ASS2 7 pin ASS2 ♂
25-6421-701	1/6		●	💡	24V	LED		7 pol. ASS2 7 pin ASS2 ♂
25-6421-731	1/6		●	LED 	24V	LED		7 pol. ASS2 7 pin ASS2 ♂
25-6421-741	1/6		●	LED 	24V	LED		7 pol. ASS2 7 pin ASS2 ♂
25-6510-501	1/6		●	💡	24V	💡		7 pol. ASS2 7 pin ASS2 ♂ 2 x 2 pol. ASS2 2 x 2 pin ASS2
25-6510-711	1/6		●	LED 	24V	LED		7 pol. ASS2 7 pin ASS2 ♂ 2 x 2 pol. ASS2 2 x 2 pin ASS2
25-6610-501	1/6		●	💡	24V	💡		7 pol. ASS2 7 pin ASS2 ♂ 4 x 2 pol. ASS2 4 x 2 pin ASS2
25-6611-501	1/6		●	💡	24V	💡		7 pol. ASS2 7 pin ASS2 ♂ 4 x 2 pol. ASS2 4 x 2 pin ASS2



EUROPOINT II

ZUBEHÖHR / ACCESSORIES



1 Lichtscheibe | lens
..... 18-8560-002

2 LED Einsätze | LED inserts
Rücklicht 12V / 24V
tail 12V / 24V..... 12-1560-001
Bremslicht 12V / 24V
stop light 12V / 24V 12-1560-141
Blinklicht 24V
direction indicator 24V... 12-1560-011
Rückfahrlicht 24V
reverse 24V..... 12-1560-021
Nebelschlusslicht 24V
fog 24V 12-1560-031

3 Relais
(a) Rückfahrwarner 24V
reverse alarm 24V
..... 12-3922-004
(b) SMCG Steuerung für Seitenmarkierungsleuchten
SMCG side marker control gear
..... 12-3970-584

4 LED Vorschaltgerät | LED control gear
LCG 1 75-0300-001
siehe Seite 166
see at page 166

5 Schutzhaube | protection cap
(a) klein
small 15-5270-004
(b) groß
big 15-5276-004

6 Umrissarm Glühlampe | outline marker bulb
rot / weiß / orange links
red / white / orange left
..... 31-3305-064
rot / weiß / orange rechts
red / white / orange right
..... 31-3306-064



7 Lichtscheibe Umrissarm | lens outline marker
..... 18-8141-004

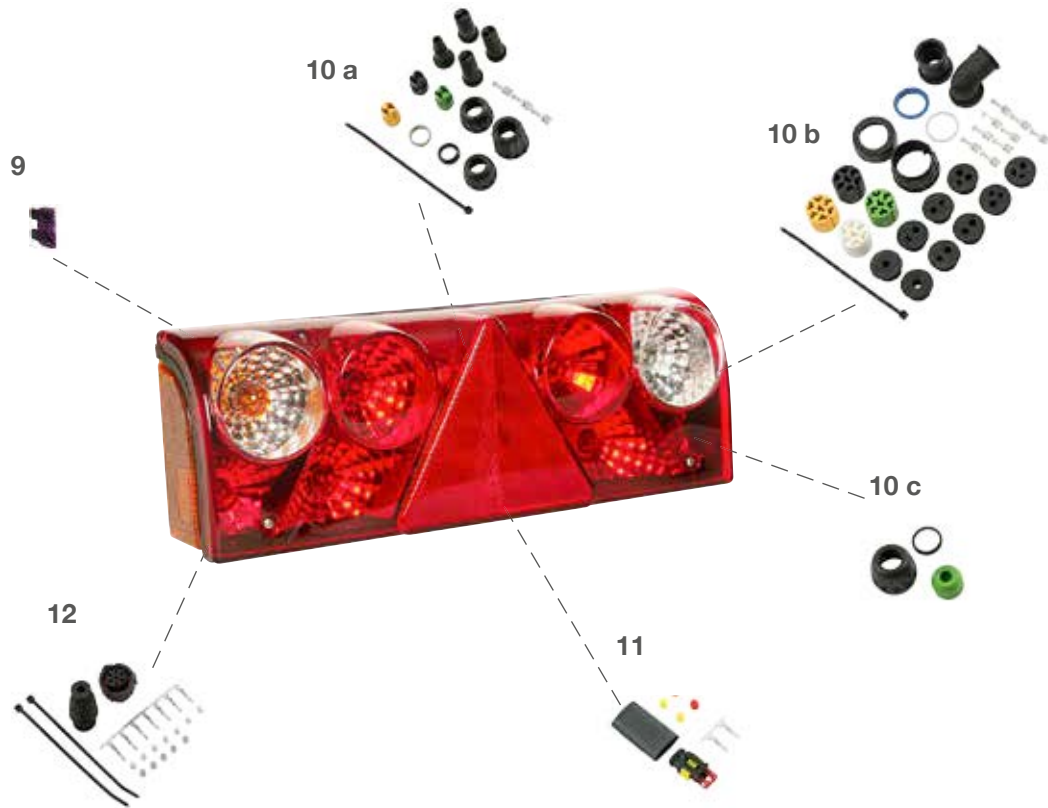

EUROPOINT II

ZUBEHÖHR / ACCESSORIES



- 8 Umrissarm LED | outline marker LED**
 rot / weiß links
 red / white left 31-3305-084 
 rot / weiß rechts
 red / white right 31-3306-084 

- 9 Sicherung | fuse**
 3 A 12-6830-094 

- 10 ASS1 & ASS2 Verbinder |
 ASS1 & ASS2 connector**
- (a) 2 pol. weiblich
 2 pin female 13-5626-401 
- (b) 7 pol. weiblich
 7 pin female 13-5626-631 
- (c) Verschlusskappe
 closed connection 15-5623-304 

- 11 Superseal Verbinder |
 Superseal connector**
 2 pol. weiblich
 2 pin female 15-7002-044 

- 12 AMP Verbinder |
 AMP connector**
 7 pol. weiblich
 7 pin female 15-7002-024 

- Glühlampe | bulb**
- 24V 21W orange 16-6321-617 
 24V 21W 16-6321-037 
 24V 10W 16-6310-027 
 24V 4W 16-6304-027 



EUROPOINT I

ADR Zone 2

IP 54

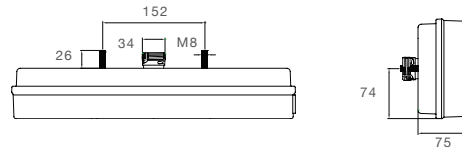
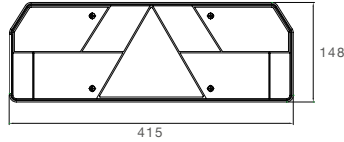

Blinklicht Direction indicator	Rücklicht Tail light	Bremslicht Stop light	Nebelschlusslicht Fog light
Rückfahrlicht Reverse light	Dreieckrückstrahler Triangle reflector	Seitenmarkierungslicht + Reflektor Sidemarker light + reflector	Begrenzungslicht hinten Rear position light

BEST. NR							ZUSATZ	ANSCHLUSS
PART NO							ADD ON	CONNECTOR
25-5000-501	1/10	●			24V			7 pol. ASS2 7 pin ASS2
25-5001-501	1/10	●			24V			7 pol. ASS2 7 pin ASS2
25-5010-501	1/10	●			24V			7 pol. ASS2 7 pin ASS2
25-5100-501	1/10	●			24V			PG Verschraubung cable glands
25-5101-521	1/10	●			24V			PG Verschraubung cable glands
35-5103-011	1/ -	●			24V			offenes Ende open end 2,70 m
25-5400-501	1/10		●		24V			7 pol. ASS2 7 pin ASS2
25-5401-501	1/10		●		24V			7 pol. ASS2 7 pin ASS2
25-5410-501	1/10		●		24V			7 pol. ASS2 7 pin ASS2
25-5500-501	1/10		●		24V			PG Verschraubung cable glands
25-5501-521	1/10		●		24V			PG Verschraubung cable glands
35-5502-011	1/ -		●		24V			offenes Ende open end 3,70 m



EUROPOINT I

ZUBEHÖR / ACCESSORIES

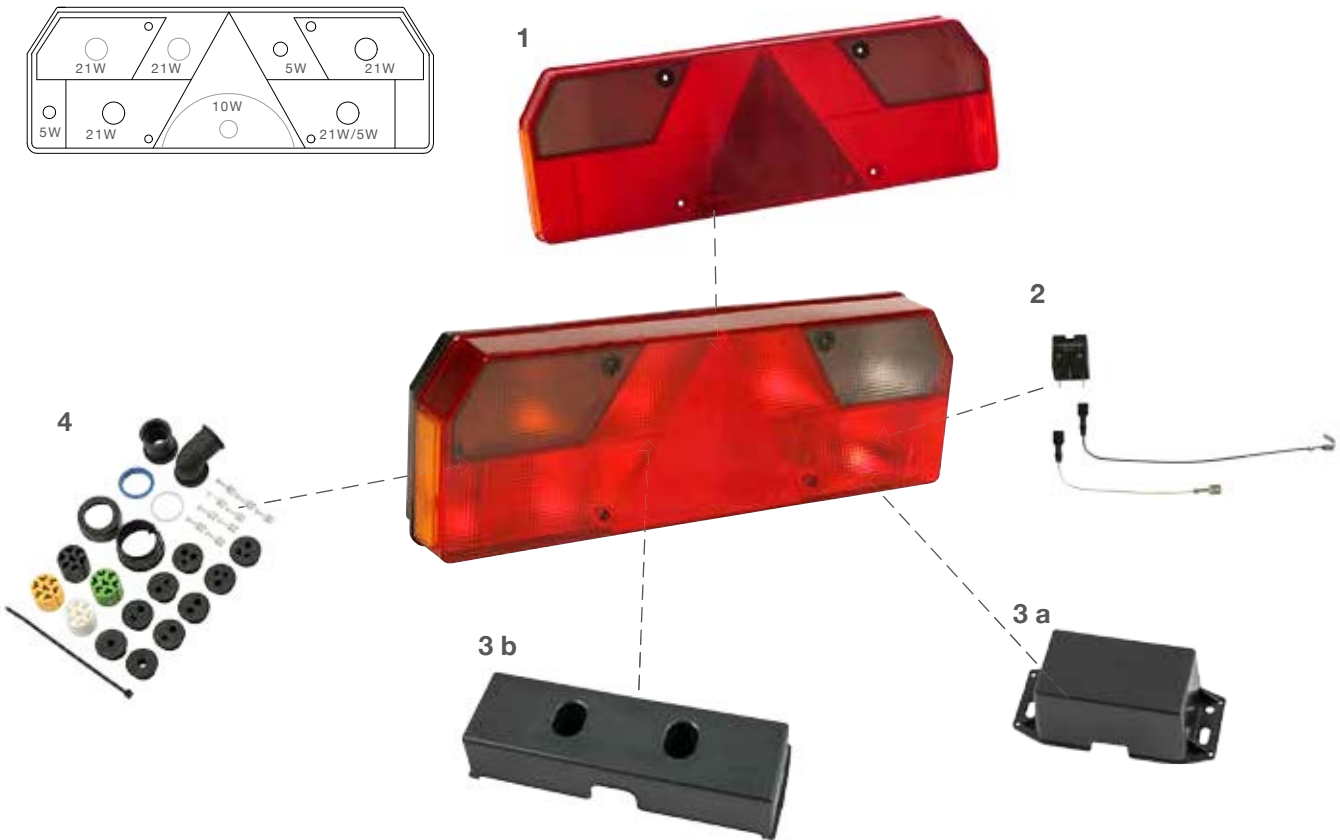

1 Lichtscheibe | lens
..... 18-8550-002

2 Rückfahrwarner 24V | reverse alarm 24V
..... 12-3922-004

3 Schutzhaube | protection cap
(a) klein
small 15-5270-004
(b) groß
big 15-5276-004

4 ASS1 & ASS2 Verbinder |
ASS1 & ASS2 connector
7 pol. weiblich
7 pin female 13-5626-631

Glühlampe | bulb
24V 21W/5W 16-6322-027
24V 21W 16-6321-037
24V 10W 16-6310-027
24V 5W 16-6305-027



ECOLED

ADR Zone 2 IP69K

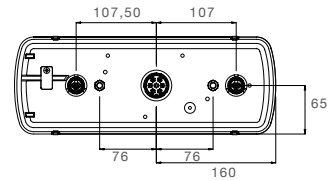
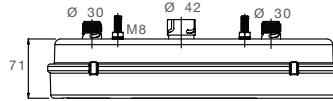
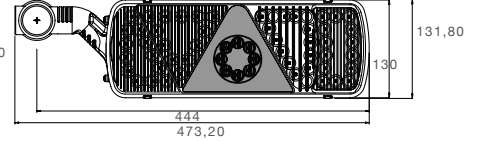
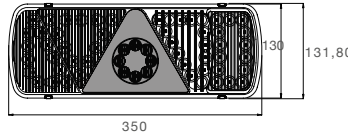

Blinklicht Direction indicator	Rücklicht Tail light	Bremslicht Stop light	Nebelschlusslicht Fog light
Rückfahrlicht Reverse light	Dreieckrückstrahler Triangle reflector	Seitenmarkierungslicht + Reflektor Sidemarker light + reflector	

BEST. NR							ZUSATZ	ANSCHLUSS				
PART NO							ADD ON	CONNECTOR				
25-3800-501	1/10	●		LED	24V			7 pol. ASS2 7 pin ASS2				
25-3800-511	1/10	●		LED	24V			7 pol. ASS2.1 7 pin ASS2.1			2 x 2 pol. ASS2 2 x 2 pin ASS2	
25-3820-511	1/-	●		LED	24V	LED		7 pol. ASS2.1 7 pin ASS2.1			2 x 2 pol. ASS2 2 x 2 pin ASS2	
25-3900-501	1/10		●	LED	24V			7 pol. ASS2 7 pin ASS2				
25-3900-511	1/10		●	LED	24V			7 pol. ASS2.1 7 pin ASS2.1			2 x 2 pol. ASS2 2 x 2 pin ASS2	
25-3920-511	1/-		●	LED	24V	LED		7 pol. ASS2.1 7 pin ASS2.1			2 x 2 pol. ASS2 2 x 2 pin ASS2	



ECOLED

ZUBEHÖHR / ACCESSORIES



1 Umrissarm LED | outline marker LED

- (a) lang rot / weiß / orange links
long red / white / orange left
..... 31-3305-244
- lang rot / weiß / orange rechts
long red / white / orange right
..... 31-3306-244
- (b) kurz rot / weiß / orange links
short red / white / orange left
..... 31-3305-234
- kurz rot / weiß / orange rechts
short red / white / orange right
..... 31-3306-234

2 Schutzhaube | protection cap

- 15-5277-004

**3 ASS1 & ASS2 Verbinder |
ASS1 & ASS2 connector**

- (a) 2 pol. weiblich
2 pin female 13-5626-401
- (b) 7 pol. weiblich
7 pin female 13-5626-631
- (c) Verschlusskappe
closed connection 15-5623-304

4 LED Vorschaltgerät | LED control gear

- 75-0309-001
- siehe Seite 166
see at page 166



ECOPOINT II

ADR Zone 2 IP56K

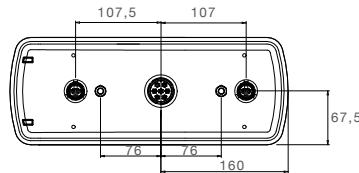
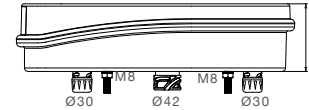
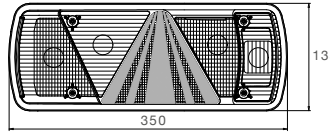

Blinklicht Direction indicator	Rücklicht Tail light	Bremslicht Stop light	Nebelschlusslicht Fog light
Rückfahrlicht Reverse light	Dreieckrückstrahler Triangle reflector	Seitenmarkierungslicht + Reflektor Sidemarker light + reflector	

BEST. NR	PART NO							ZUSATZ ADD ON	ANSCHLUSS CONNECTOR
25-2800-001	1/6	●				24V		7 pol. ASS2.1 7 pin ASS2.1	
25-2800-451	1/6	●				24V		7 pol. ASS2 7 pin ASS2	
25-2800-501	1/6	●				24V		7 pol. ASS2 7 pin ASS2	
25-2800-511	1/6	●				24V		7 pol. ASS2 7 pin ASS2	2 x 2 pol. ASS2 2 x 2 pin ASS2
25-2800-521	1/6	●				24V		7 pol. ASS2 7 pin ASS2	2 x 2 pol. ASS2 2 x 2 pin ASS2
25-2801-001	1/-	●				24V		7 pol. ASS2 7 pin ASS2	
25-2801-501	1/6	●				24V		7 pol. ASS2 7 pin ASS2	
25-2860-001	1/6	●				24V		7 pol. ASS2.1 7 pin ASS2.1	
25-2801-701	1/6	●				24V		7 pol. ASS2.1 7 pin ASS2.1	
25-2860-701	1/8	●				24V		7 pol. ASS2.1 7 pin ASS2.1	
25-2880-521	1/6	●				24V		7 pol. AMP 7 pin AMP	2 x 2 pol. Superseal 2 x 2 pin Superseal



ECOPOINT II

ADR Zone 2 IP56K

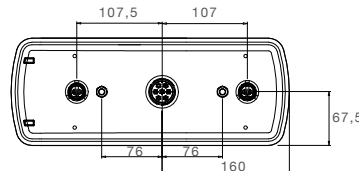
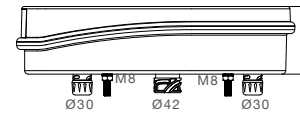
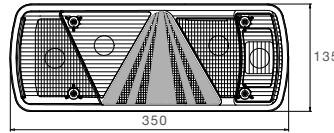

Blinklicht Direction indicator	Rücklicht Tail light	Bremslicht Stop light	Nebelschlusslicht Fog light
Rückfahrlicht Reverse light	Dreieckrückstrahler Triangle reflector	Seitenmarkierungslicht + Reflektor Sidemarker light + reflector	

BEST. NR PART NO							ZUSATZ ADD ON	ANSCHLUSS CONNECTOR
25-2900-001	1/6		●		24V		7 pol. ASS2 7 pin ASS2	
25-2900-451	1/6		●		24V		7 pol. ASS2 7 pin ASS2	
25-2900-501	1/6		●		24V		7 pol. ASS2 7 pin ASS2	
25-2900-511	1/6		●		24V		7 pol. ASS2 7 pin ASS2	2 x 2 pol. ASS2 2 x 2 pin ASS2
25-2900-521	1/6		●		24V		7 pol. ASS2 7 pin ASS2	2 x 2 pol. ASS2 2 x 2 pin ASS2
25-2901-001	1/-		●		24V		7 pol. ASS2 7 pin ASS2	
25-2901-501	1/6		●		24V		7 pol. ASS2 7 pin ASS2	
25-2901-551	1/-		●		24V		7 pol. ASS2.1 7 pin ASS2.1	
25-2960-001	1/6		●		24V		7 pol. ASS2.1 7 pin ASS2.1	
25-2901-701	1/6		●		24V		7 pol. ASS2.1 7 pin ASS2.1	
25-2960-701	1/8		●		24V		7 pol. ASS2.1 7 pin ASS2.1	
25-2980-521	1/6		●		24V		7 pol. AMP 7 pin AMP	2 x 2 pol. Superseal 2 x 2 pin Superseal



ECOPOINT II mit Umrissarm
with end outline marker

ADR Zone 2 IP56K

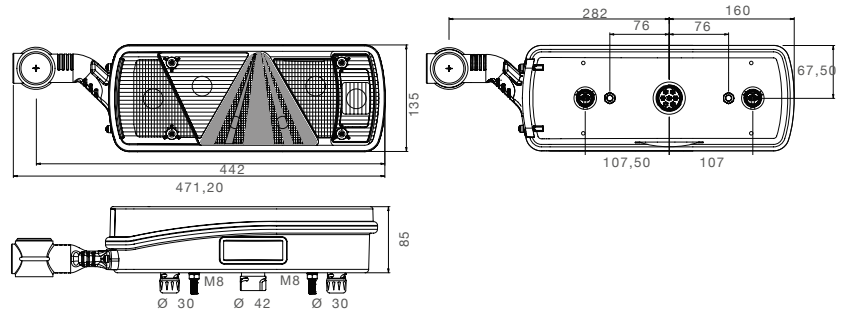

Blinklicht Direction indicator	Rücklicht Tail light	Bremslicht Stop light	Nebelschlusslicht Fog light
Rückfahrlicht Reverse light	Dreieckrückstrahler Triangle reflector	Seitenmarkierungslicht + Reflektor Sidemarker light + reflector	

BEST. NR PART NO							ZUSATZ ADD ON	ANSCHLUSS CONNECTOR
25-2810-511	1/-	●			24V			7 pol. ASS2 7 pin ASS2 ♂ 2 x 2 pol. ASS2 2 x 2 pin ASS2
25-2811-501	1/8	●			24V			7 pol. ASS2 7 pin ASS2 ♂
25-2870-401	1/-	●			24V			7 pol. ASS2.1 7 pin ASS2.1 ♂
25-2810-501	1/8	●			24V			7 pol. ASS2 7 pin ASS2 ♂
25-2831-501	1/6	●			24V	lang		7 pol. ASS2.1 7 pin ASS2.1 ♂ 2 x 2 pol. ASS2 2 x 2 pin ASS2
25-2832-501	1/6	●			24V	lang		7 pol. ASS2.1 7 pin ASS2.1 ♂
25-2810-451	1/-	●			24V	lang		7 pol. ASS2.1 7 pin ASS2.1 ♂
25-2820-741	1/-	●			24V	lang		7 pol. ASS2.1 7 pin ASS2.1 ♂ 2 x 2 pol. ASS2 2 x 2 pin ASS2
25-2820-501	1/8	●			24V			7 pol. ASS2 7 pin ASS2 ♂
25-2820-541	1/8	●			24V			7 pol. ASS2.1 7 pin ASS2.1 ♂ 2 x 2 pol. ASS2 2 x 2 pin ASS2
25-2880-531	1/8	●			24V			7 pol. AMP 7 pin AMP ♂ 2 x 2 pol. Superseal 2 x 2 pin Superseal
25-2910-501	1/8		●		24V			7 pol. ASS2 7 pin ASS2 ♂



ECOPOINT II mit Umrissarm
with end outline marker

ADR Zone 2 IP56K

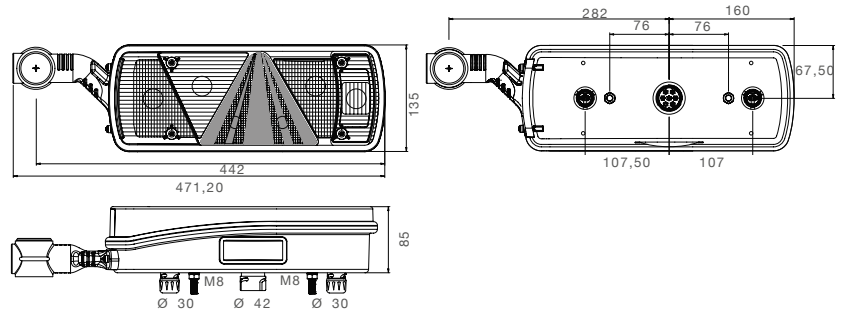

Blinklicht Direction indicator	Rücklicht Tail light	Bremslicht Stop light	Nebelschlusslicht Fog light
Rückfahrlicht Reverse light	Dreieckrückstrahler Triangle reflector	Seitenmarkierungslicht + Reflektor Sidemarker light + reflector	

BEST. NR	PART NO							ZUSATZ ADD ON	ANSCHLUSS CONNECTOR
25-2910-511	1/-		●			24V			7 pol. ASS2 7 pin ASS2 ♂ 2 x 2 pol. ASS2 2 x 2 pin ASS2
25-2910-551	1/-		●			24V		 	7 pol. ASS2.1 7 pin ASS2.1 ♂ 2 x 2 pol. ASS2 2 x 2 pin ASS2
25-2911-501	1/8		●			24V		 	7 pol. ASS2 7 pin ASS2 ♂
25-2911-551	1/-		●			24V		 	7 pol. ASS2.1 7 pin ASS2.1 ♂
25-2970-401	1/-		●			24V		 	7 pol. ASS2.1 7 pin ASS2.1 ♂
25-2910-451	1/-		●			24V	 lang long		7 pol. ASS2.1 7 pin ASS2.1 ♂
25-2931-501	1/6		●			24V	 lang long	 	7 pol. ASS2.1 7 pin ASS2.1 ♂ 2 x 2 pol. ASS2 2 x 2 pin ASS2
25-2920-741	1/-		●			24V	 lang long		7 pol. ASS2.1 7 pin ASS2.1 ♂ 2 x 2 pol. ASS2 2 x 2 pin ASS2
25-2932-501	1/6		●			24V	 lang long		7 pol. ASS2 7 pin ASS2 ♂
25-2920-501	1/8		●			24V			7 pol. ASS2 7 pin ASS2 ♂
25-2920-541	1/8		●			24V			7 pol. ASS2.1 7 pin ASS2.1 ♂ 2 x 2 pol. ASS2 2 x 2 pin ASS2
25-2980-531	1/8		●			24V			7 pol. AMP 7 pin AMP ♂ 2 x 2 pol. Superseal 2 x 2 pin Superseal



ECOPOINT II

ZUBEHÖHR / ACCESSORIES

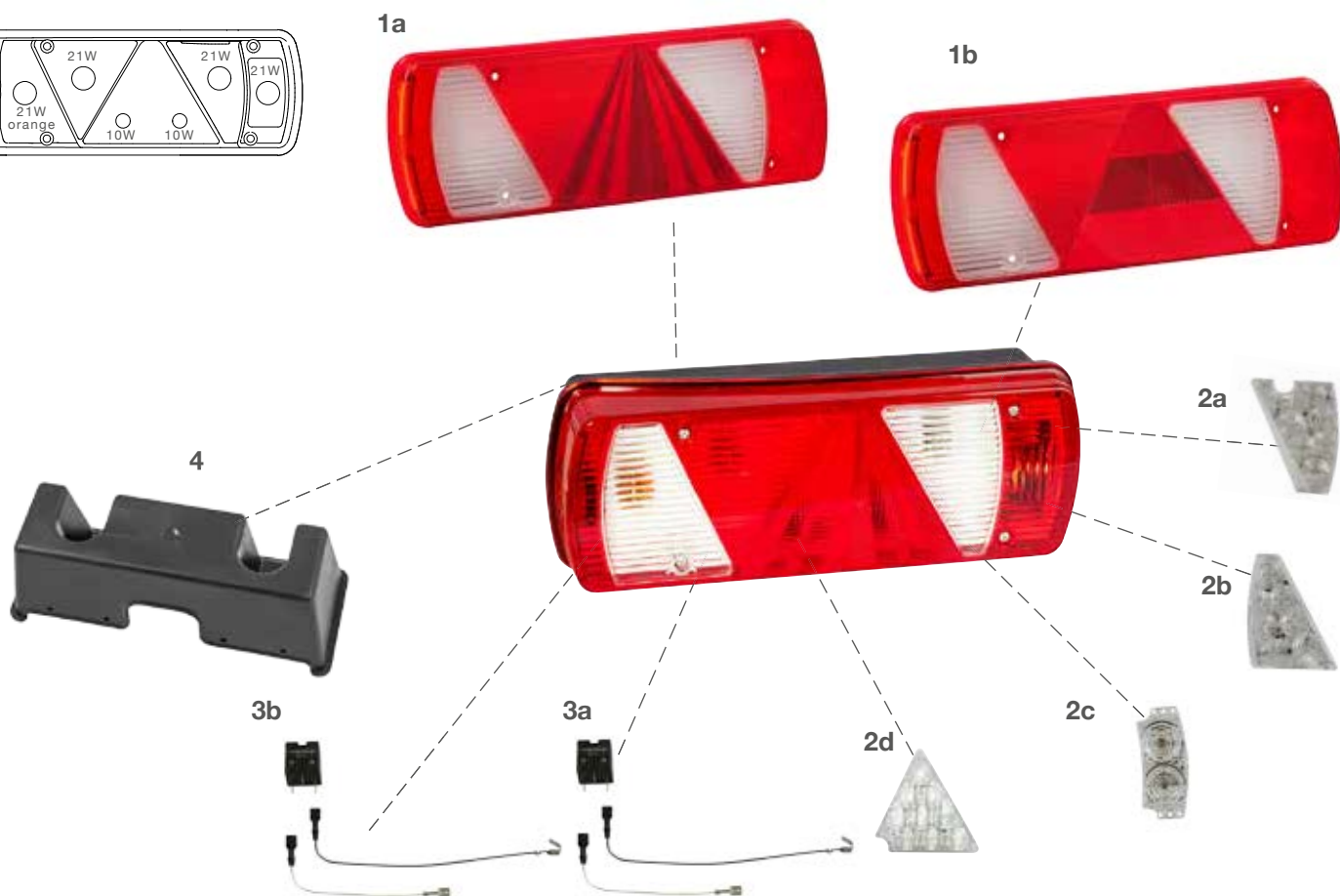
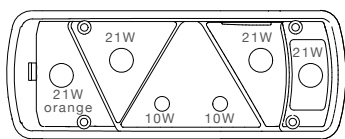

1 Lichtscheibe | lens

- (a) links
left..... 18-8528-002
- rechts
right 18-8529-002
- (b) links ohne Dreieck
left without triangle 18-8526-002
- rechts ohne Dreieck
right without triangle 18-8527-002

2 LED Einsätze | LED inserts

- (a) Blinklicht links ^{24V}
direction indicator left ^{24V}
..... 12-1522-154
- Blinklicht rechts ^{24V}
direction indicator right ^{24V}
..... 12-1526-154
- (b) Rückfahrlicht links ^{24V}
reverse left ^{24V}
..... 12-1522-144
- Rückfahrlicht rechts ^{24V}
reverse right ^{24V}
..... 12-1526-144

- (c) Nebelschlusslicht links / rechts ^{24V}
fog left / right ^{24V}
..... 12-1526-164
- (d) Rücklicht und Bremslicht links ^{24V}
tail light and stop light left ^{24V}
..... 12-1528-001
- Rücklicht und Bremslicht rechts ^{24V}
tail light and stop light right ^{24V}
..... 12-1529-001

3 Relais

- (a) Rückfahrwarner ^{24V}
reverse alarm ^{24V}
..... 12-3922-004
- (b) SMCG Steuerung für Seitenmarkierungsleuchten
SMCG side marker control gear
..... 12-3970-584

4 Schutzhaube | protection cap

- 15-5277-004



ECOPOINT II

ZUBEHÖHR / ACCESSORIES



5 Umrissarm Glühlampe | outline marker bulb

- (a) links kurz
left short..... 31-3303-024
- rechts kurz
right short 31-3302-024
- (b) links lang
links long 31-3303-034
- rechts lang
rechts long..... 31-3302-034

6 Lichtscheibe Umrissarm | lens outline marker
..... 18-8141-004

7 Umrissarm LED | outline marker LED

- a) links kurz
left short..... 31-3303-044
- rechts kurz
right short 31-3302-044
- b) links lang
links long 31-3303-104
- rechts lang
rechts long..... 31-3302-104

8 ASS1 & ASS2 Verbinder | ASS1 & ASS2 connector

- (a) 2 pol. weiblich
2 pin female 13-5626-401
- (b) 7 pol. weiblich
7 pin female 13-5626-631
- (c) Verschlusskappe
closed connection 15-5623-304

9 Superseal Verbinder | Superseal connector

- 2 pol. weiblich
2 pin female 15-7002-044

10 AMP Verbinder | AMP connector

- 7 pol. weiblich
7 pin female 15-7002-024

Glühlampe | bulb

- 24V 21W orange 16-6321-617
- 24V 21W 16-6321-037
- 24V 10W 16-6310-027
- 24V 4W 16-6304-027



ECOPOINT I mit Dreieck
with triangle

ADR
Zone 2

IP 54

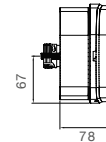
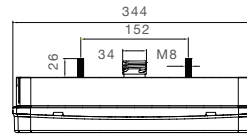
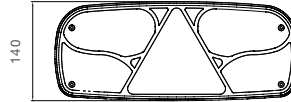

Blinklicht Direction indicator	Rücklicht Tail light	Bremslicht Stop light	Nebelschlusslicht Fog light
Rückfahrlicht Reverse light	Dreieckrückstrahler Triangle reflector		

BEST. NR		←	→	💡	⚡	🔦	ZUSATZ	ANSCHLUSS
PART NO							ADD ON	CONNECTOR
25-2200-001	1/15	●		💡	24V			7 pol. ASS2 7 pin ASS2 ♂
25-2200-701	1/15	●		LED 	24V			7 pol. ASS2 7 pin ASS2 ♂
25-2200-711	1/15	●		LED 	24V			7 pol. ASS2 7 pin ASS2 ♂
25-2200-721	1/15	●		LED 	24V			7 pol. ASS2 7 pin ASS2 ♂
25-2200-731	1/15	●		LED	24V			7 pol. ASS2 7 pin ASS2 ♂
25-2200-741	1/15	●		LED 	24V			7 pol. ASS2 7 pin ASS2 ♂
25-2201-001	1/15	●		💡	24V			7 pol. ASS2 7 pin ASS2 ♂
25-2201-701	1/15	●		LED 	24V			7 pol. ASS2 7 pin ASS2 ♂
25-2201-731	1/15	●		LED	24V			7 pol. ASS2 7 pin ASS2 ♂



ECOPOINT I mit Dreieck
with triangle

ADR Zone 2

IP 54

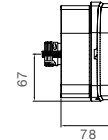
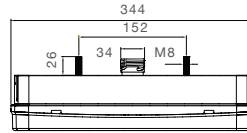
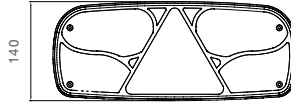

Blinklicht Direction indicator	Rücklicht Tail light	Bremslicht Stop light	Nebelschlusslicht Fog light
Rückfahrlicht Reverse light	Dreieckrückstrahler Triangle reflector		

BEST. NR	PART NO							ZUSATZ ADD ON	ANSCHLUSS CONNECTOR
25-2600-001	1/15		●		24V			7 pol. ASS2 7 pin ASS2	
25-2600-701	1/15		●		24V			7 pol. ASS2 7 pin ASS2	
25-2600-711	1/15		●		24V			7 pol. ASS2 7 pin ASS2	
25-2600-721	1/15		●		24V			7 pol. ASS2 7 pin ASS2	
25-2600-731	1/15		●		24V			7 pol. ASS2 7 pin ASS2	
25-2600-741	1/15		●		24V			7 pol. ASS2 7 pin ASS2	
25-2601-001	1/15		●		24V			7 pol. ASS2 7 pin ASS2	
25-2601-701	1/15		●		24V			7 pol. ASS2 7 pin ASS2	
25-2601-731	1/15		●		24V			7 pol. ASS2 7 pin ASS2	



ECOPOINT I mit Dreieck
with triangle

ADR Zone 2

IP 54

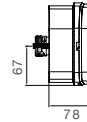
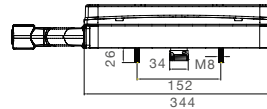
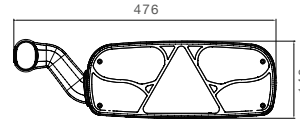

Blinklicht Direction indicator	Rücklicht Tail light	Bremslicht Stop light	Nebelschlusslicht Fog light
Rückfahrlicht Reverse light	Dreieckrückstrahler Triangle reflector		

BEST. NR	PART NO		←	→				ZUSATZ ADD ON	ANSCHLUSS CONNECTOR
25-2210-001	1/8	●				24V			7 pol. ASS2 7 pin ASS2 ♂
25-2210-701	1/8	●			LED 	24V			7 pol. ASS2 7 pin ASS2 ♂
25-2210-711	1/8	●			LED 	24V			7 pol. ASS2 7 pin ASS2 ♂
25-2210-721	1/8	●			LED 	24V			7 pol. ASS2 7 pin ASS2 ♂
25-2210-731	1/8	●			LED 	24V			7 pol. ASS2 7 pin ASS2 ♂
25-2210-761	1/-	●			LED 	24V	LED		7 pol. ASS2 7 pin ASS2 ♂
25-2210-781	1/-	●			LED 	24V	LED		7 pol. ASS2 7 pin ASS2 ♂
25-2211-001	1/8	●				24V			7 pol. ASS2 7 pin ASS2 ♂
25-2211-701	1/8	●			LED 	24V			7 pol. ASS2 7 pin ASS2 ♂
25-2211-711	1/8	●			LED 	24V			7 pol. ASS2 7 pin ASS2 ♂
25-2211-721	1/8	●			LED 	24V			7 pol. ASS2 7 pin ASS2 ♂
25-2211-731	1/8	●			LED 	24V			7 pol. ASS2 7 pin ASS2 ♂

ECOPOINT I mit Dreieck
with triangle

ADR Zone 2

IP 54

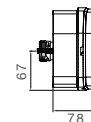
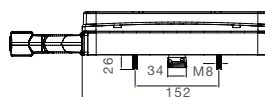
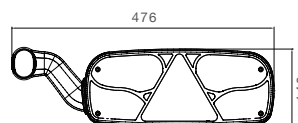

Blinklicht Direction indicator	Rücklicht Tail light	Bremslicht Stop light	Nebelschlusslicht Fog light
Rückfahrlicht Reverse light	Dreieckrückstrahler Triangle reflector		

BEST. NR	PART NO							ZUSATZ ADD ON	ANSCHLUSS CONNECTOR
25-2610-001	1/8		●		24V			7 pol. ASS2 7 pin ASS2	
25-2610-701	1/8		●	LED 	24V			7 pol. ASS2 7 pin ASS2	
25-2610-711	1/8		●	LED 	24V			7 pol. ASS2 7 pin ASS2	
25-2610-721	1/8		●	LED 	24V			7 pol. ASS2 7 pin ASS2	
25-2610-731	1/8		●	LED 	24V			7 pol. ASS2 7 pin ASS2	
25-2610-771	1/-		●	LED 	24V	LED		7 pol. ASS2 7 pin ASS2	
25-2610-791	1/-		●	LED 	24V	LED		7 pol. ASS2 7 pin ASS2	
25-2611-001	1/8		●		24V			7 pol. ASS2 7 pin ASS2	
25-2611-701	1/8		●	LED 	24V			7 pol. ASS2 7 pin ASS2	
25-2611-711	1/8		●	LED 	24V			7 pol. ASS2 7 pin ASS2	
25-2611-721	1/8		●	LED 	24V			7 pol. ASS2 7 pin ASS2	
25-2611-731	1/8		●	LED 	24V			7 pol. ASS2 7 pin ASS2	



ECOPOINT I mit Dreieck
with triangle

ZUBEHÖHR / ACCESSORIES

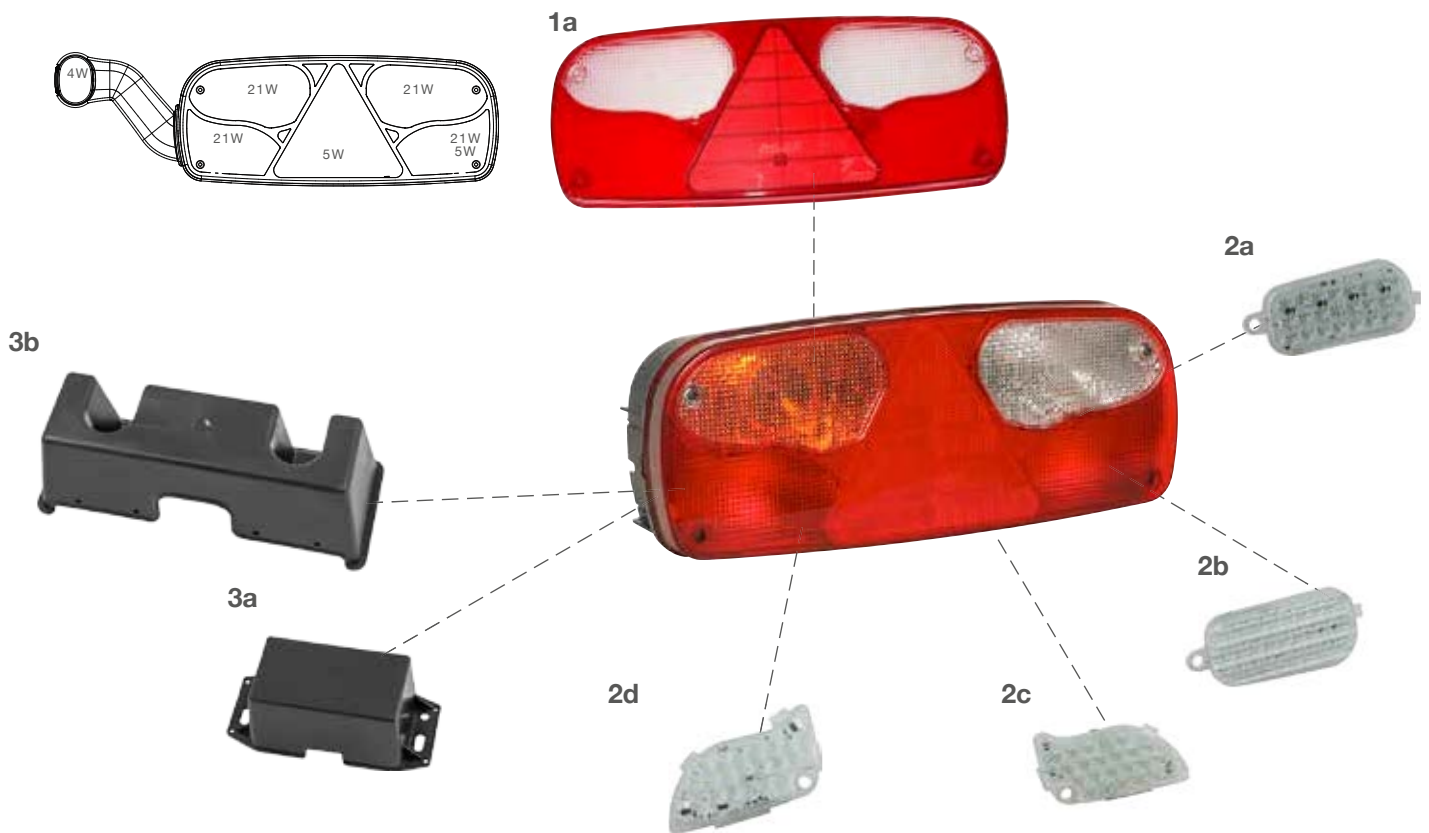

1 Lichtscheibe | lens

- (a) links / rechts
left / right..... 18-8522-002
- (b) links / rechts ohne Reflektor
left /right without reflector
..... 18-8522-102

2 LED Einsätze | LED inserts

- (a) Blinklicht links 24V
direction indicator left 24V
..... 12-1522-014
- Blinklicht rechts 24V
direction indicator right 24V
..... 12-1526-014
- (b) Rückfahrlicht links 24V
reverse left 24V..... 12-1522-034
- Rückfahrlicht rechts 24V
reverse right 24V..... 12-1526-034

- (c) Nebelschlusslicht links 24V
fog left 24V..... 12-1522-024
- Nebelschlusslicht rechts 24V
fog right 24V 12-1526-024
- (d) Rücklicht und Bremslicht links 24V
tail light and stop light left 24V
..... 12-1522-004
- Rücklicht und Bremslicht rechts 24V
tail light and stop light right 24V
..... 12-1526-004

3 Schutzhaube | protection cap

- (a) klein
small 15-5270-004
- (b) groß
big 15-5276-004



ECOPOINT | mit Dreieck
with triangle

ZUBEHÖHR / ACCESSORIES



4 Umrissarm Glühlampe | outline marker bulb

- links
left..... 31-3608-014
- rechts
right 31-3608-004

5 Lichtscheibe Umrissarm | lens outline marker

- 18-8136-004

6 Umrissarm LED | outline marker LED

- links
left..... 31-3305-174
- rechts
right 31-3306-174

7 ASS1 & ASS2 Verbinder |
ASS1 & ASS2 connector

- 7 pol. weiblich
7 pin female 13-5626-631

8 ASS3 Verbinder | ASS3 connector

- (a) 17 pol. weiblich
17 pin female 13-1722-001
- (b) 17 pol. männlich
17 pin male 13-1732-001

Glühlampe | bulb

- 24V 21W / 5W 16-6322-037
- 24V 21W 16-6321-037
- 24V 5W 16-6305-027
- 24V 4W 16-6304-027



ECOPOINT I ohne Dreieck
without triangle

ADR Zone 2

IP 54

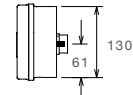
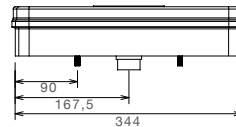
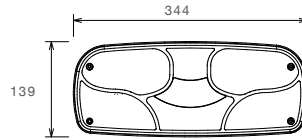

Blinklicht Direction indicator	Rücklicht Tail light	Bremslicht Stop light	Nebelschlusslicht Fog light
Rückfahrlicht Reverse light			

BEST. NR	PART NO		←	→				ZUSATZ ADD ON	ANSCHLUSS CONNECTOR		
25-2000-501	1/15		●			24V			7 pol. ASS2 7 pin ASS2	♂	
25-2001-501	1/15		●			24V			7 pol. ASS2 7 pin ASS2	♂	
25-2100-501	1/15		●			24V			PG Verschraubung cable glands		
35-2103-061	1/15		●			24V			ASS3 17 pol. ASS3 17 pin	♀	0,90 m
25-2400-501	1/15			●		24V			7 pol. ASS2 7 pin ASS2	♂	
25-2401-501	1/15			●		24V			7 pol. ASS2 7 pin ASS2	♂	
25-2500-501	1/15			●		24V			PG Verschraubung cable glands		
35-2502-071	1/15			●		24V			ASS3 17 pol. ASS3 17 pin	♀	0,90 m



ECOPOINT I ohne Dreieck
without triangle

ADR Zone 2

IP 54

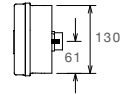
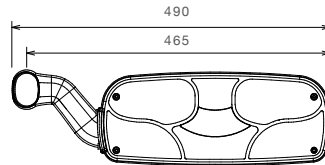

Blinklicht Direction indicator	Rücklicht Tail light	Bremslicht Stop light	Nebelschlusslicht Fog light
Rückfahrlicht Reverse light			

BEST. NR	PART NO							ZUSATZ ADD ON	ANSCHLUSS CONNECTOR
25-2010-501	1/8	●			24V			7 pol. ASS2 7 pin ASS2	♂
25-2011-501	1/8	●			24V			7 pol. ASS2 7 pin ASS2	♂
35-2103-051	1/-	●			24V			ASS3 17 pol. ASS3 17 pin	♀ 0,90 m
25-2410-501	1/8		●		24V			7 pol. ASS2 7 pin ASS2	♂
25-2411-501	1/8		●		24V			7 pol. ASS2 7 pin ASS2	♂
35-2502-051	1/-		●		24V			ASS3 17 pol. ASS3 17 pin	♀ 0,90 m



ECOPOINT | ohne Dreieck
without triangle

ZUBEHÖHR / ACCESSORIES



- 1** Lichtscheibe | lens
links / rechts
left / right..... 18-8520-002
- 2** Schutzhaube | protection cap
 - (a) klein
small 15-5270-004
 - (b) groß
big 15-5276-004

- 3** ASS1 & ASS2 Verbinder |
ASS1 & ASS2 connector
7 pol. weiblich
7 pin female 13-5626-631
- 4** ASS3 Verbinder | ASS3 connector
17 pol. männlich
17 pin male 13-1732-001



ECOPOINT | ohne Dreieck
without triangle

ZUBEHÖHR / ACCESSORIES



5 Umrissarm Glühlampe | outline marker bulb

- links
- left..... 31-3608-014
- rechts
- right 31-3608-004

Glühlampe | bulb

- 24V 21W / 5W 16-6322-037
- 24V 21W 16-6321-037
- 24V 5W 16-6305-027
- 24V 4W 16-6304-027

6 Lichtscheibe Umrissarm | lens outline marker

- 18-8136-004



ECOFLEX

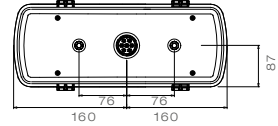
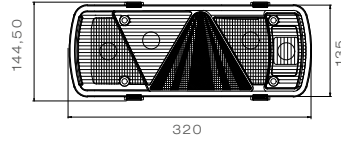

Blinklicht Direction indicator	Rücklicht Tail light	Bremslicht Stop light	Nebelschlusslicht Fog light
Rückfahrlicht Reverse light	Dreieckrückstrahler Triangle reflector		

BEST. NR	PART NO		←	→				ZUSATZ ADD ON	ANSCHLUSS CONNECTOR
25-2800-401	1/6	●			24V			7 pol. ASS2.1 7 pin ASS2.1	♂
25-2810-401	1/8	●			24V			7 pol. ASS2.1 7 pin ASS2.1	♂
25-2820-401	1/8	●			24V	LED		7 pol. ASS2.1 7 pin ASS2.1	♂
25-2900-401	1/6		●		24V			7 pol. ASS2.1 7 pin ASS2.1	♂
25-2910-401	1/8		●		24V			7 pol. ASS2.1 7 pin ASS2.1	♂
25-2920-401	1/8		●		24V	LED		7 pol. ASS2.1 7 pin ASS2.1	♂



ECOFLEX

ZUBEHÖHR / ACCESSORIES



- 1 Lichtscheibe | lens**
links
left..... 18-8528-402
- rechts
right 18-8529-402

- 2 Clip für Lichtscheibe | clip for lens**
..... 15-5323-004

- 3 LED Einsätze | LED insert**
Rücklicht / Bremslicht links
tail light / stop light left
..... 12-1528-001
- Rücklicht / Bremslicht rechts
tail light / stop light right
..... 12-1529-001

- 4 ASS1 & ASS2 Verbinder | ASS1 & ASS2 connector**
7 pol. weiblich
7 pin female 13-5626-631

- 5 Umrissarm Glühlampe | outline marker bulb**
(a) links lang
left long..... 31-3303-034

- rechts lang
right long..... 31-3302-034
- (b) links kurz
left short..... 31-3303-024
- rechts kurz
right short 31-3302-024

- 6 Lichtscheibe Umrissarm | lens outline marker**
..... 18-8141-004

- 7 Umrissarm LED | outline marker LED**
(a) links lang
left long..... 31-3303-104
- rechts lang
right long..... 31-3302-104
- (b) links kurz
left short..... 31-3303-044
- rechts kurz
right short 31-3302-044

- Glühlampe | bulb**
24V 21W orange 16-6321-617
- 24V 21W 16-6321-037
- 24V 10W 16-6310-027
- 24V 4W 16-6304-027



EUROFAB

ADR Zone 2 IP56K

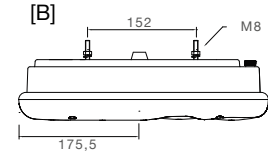
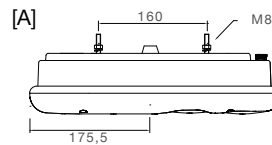
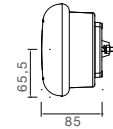
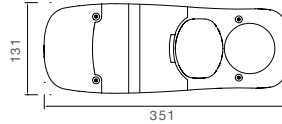

Blinklicht Direction indicator	Rücklicht Tail light	Bremslicht Stop light	Nebelschlusslicht Fog light
Rückfahrlicht Reverse light			

BEST. NR							ZUSATZ	ANSCHLUSS
PART NO							ADD ON	CONNECTOR
25-8050-161	1/-	●			12V		[B]	Tülleneingang grommet
25-8100-001	1/-	●			12V 24V		[A]	Tülleneingang grommet
25-8100-161	1/-	●			12V		[A]	Tülleneingang grommet
25-8100-201	1/-	●			12V		[A]	7 pol. AMP 7 pin AMP
25-8100-501	1/-	●			24V		[A]	7 pol. AMP 7 pin AMP
25-8250-161	1/-		●		12V		[B]	Tülleneingang grommet
25-8300-001	1/-		●		12V 24V		[A]	Tülleneingang grommet
25-8300-161	1/-		●		12V		[A]	Tülleneingang grommet
25-8300-201	1/-		●		12V		[A]	7 pol. AMP 7 pin AMP
25-8300-501	1/-		●		24V		[A]	7 pol. AMP 7 pin AMP



EUROFAB

ZUBEHÖHR / ACCESSORIES

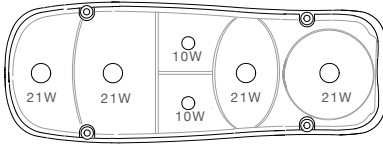

1 Lichtscheibe | lens
links / rechts
left / right..... 18-8580-001

2 AMP Verbinder | AMP connector
7 pol. weiblich
7 pin female 15-7002-024

Glühlampe | bulb
24V 21W 16-6321-037
24V 10W 16-6310-027
12V 21W 16-6121-017
12V 10W 16-6110-017



EARPOINT LED

ADR Zone 2 IP6K9K

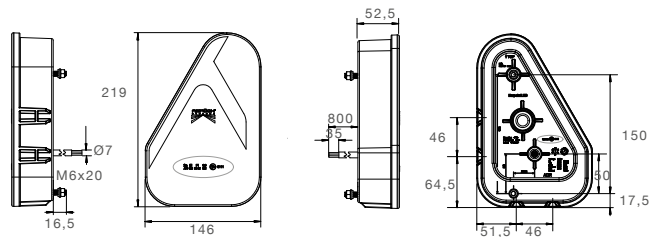

Blinklicht Direction indicator	Rücklicht Tail light	Bremslicht Stop light	Nebelschlusslicht Fog light
Rückfahrlicht Reverse light	Dreieckrückstrahler Triangle reflector		

BEST. NR		←	→	💡	⚡	👉	ZUSATZ	ANSCHLUSS
PART NO				LED	12V 24V		ADD ON	CONNECTOR
35-0301-001	1/-	●		LED	12V 24V			offenes Ende open end 0,80 m
35-0301-011	1/-	●		LED	12V 24V			5 pol. Bajonett 5 pin Bayonet 0,80 m
35-0301-021	1/-	●		LED	12V 24V			8 pol. Bajonett 8 pin Bayonet 0,80 m
35-0301-041	1/-	●		LED	12V 24V			7 pol. ASS2 7 pin ASS2 0,80 m
35-0302-001	1/-		●	LED	12V 24V			offenes Ende open end 0,80 m
35-0302-011	1/-		●	LED	12V 24V			5 pol. Bajonett 5 pin Bayonet 0,80 m
35-0302-021	1/-		●	LED	12V 24V			8 pol. Bajonett 8 pin Bayonet 0,80 m
35-0302-041	1/-		●	LED	12V 24V			7 pol. ASS2 7 pin ASS2 0,80 m



EARPOINT LED

ZUBEHÖHR / ACCESSORIES

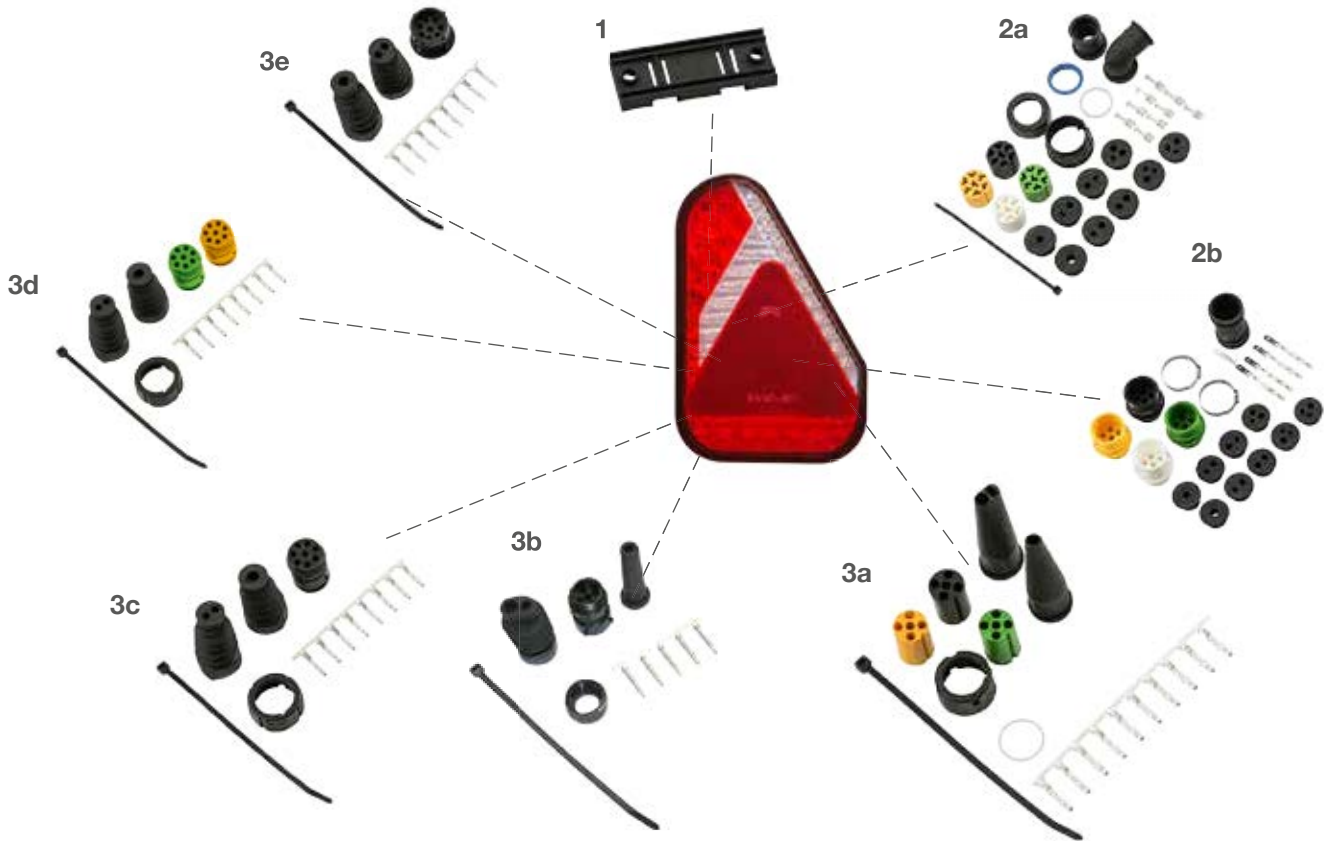

1 Halter | bracket
..... 15-5303-004

**2 ASS1 & ASS2 Verbinder |
ASS1 & ASS2 connector**
(a) 7 pol. weiblich
7 pin female 13-5626-631
(b) 7 pol. männlich
7 pin male 13-5625-981

3 Bajonett Verbinder | bayonet connector
(a) 5 pol. weiblich
5 pin female 13-0521-104
(b) 5 pol. männlich
5 pin male 13-0536-044
(c) 8 pol. weiblich
8 pin female 13-0828-034
(d) 8 pol. weiblich
8 pin female 15-0821-524
(d) 8 pol. männlich
8 pin male 13-0838-054



EARPOINT I

ADR
Zone 2

IP 54

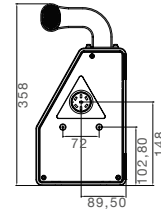
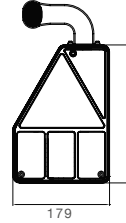
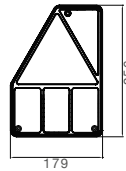

Blinklicht Direction indicator	Rücklicht Tail light	Bremslicht Stop light	
	Dreieckrückstrahler Triangle reflector		

BEST. NR							ZUSATZ	ANSCHLUSS
PART NO							ADD ON	CONNECTOR
24-4101-001	1/-	●			24V			7 pol. ASS2 7 pin ASS2
24-4105-001	1/-	●			24V			7 pol. ASS2 7 pin ASS2
24-4111-001	1/-	●			24V			PG Verschraubung cable glands
24-4151-001	-/-	●			24V			7 pol. ASS2 7 pin ASS2
24-4301-001	1/-		●		24V			7 pol. ASS2 7 pin ASS2
24-4305-001	-/-		●		24V			7 pol. ASS2 7 pin ASS2
24-4311-001	-/-		●		24V			PG Verschraubung cable glands
24-4351-001	1/-		●		24V			7 pol. ASS2 7 pin ASS2



EARPOINT I

ZUBEHÖHR / ACCESSORIES

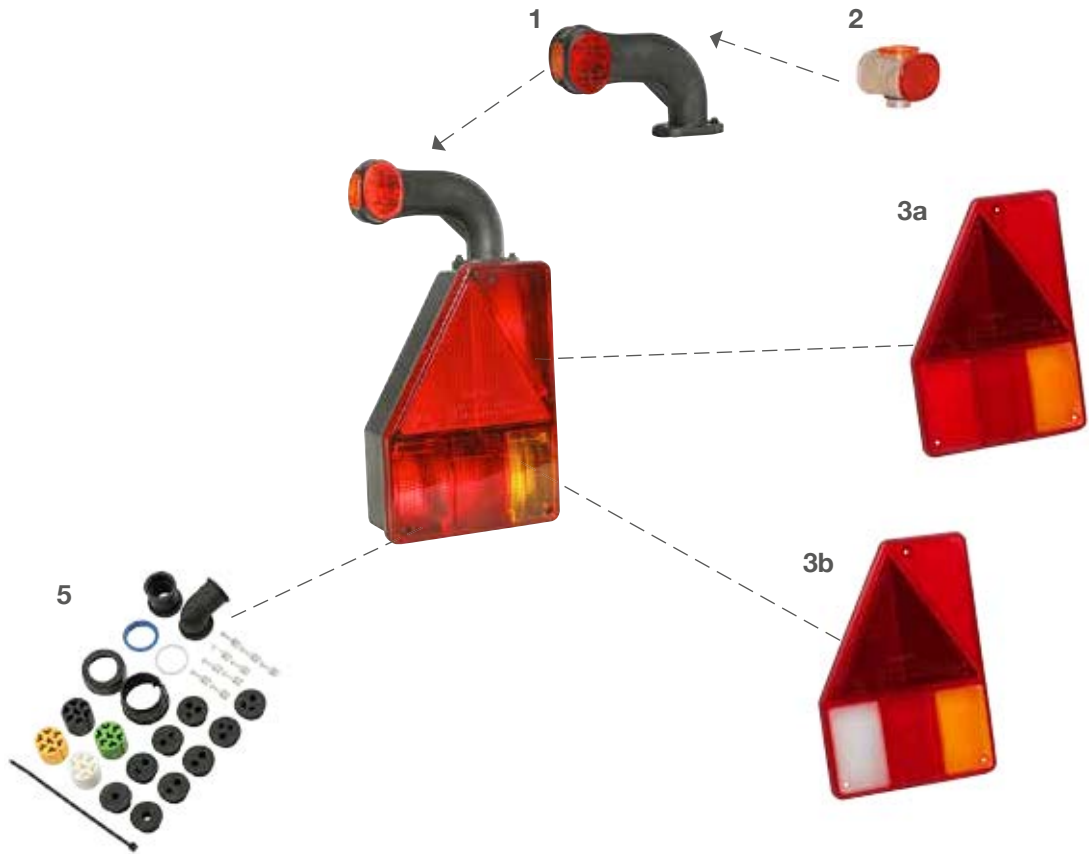
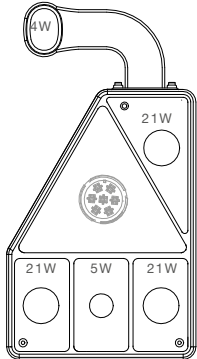

1 Umrissarm Glühlampe | outline marker bulb
..... 21-3800-004

2 Lichtscheibe Umrissarm | lens outline marker
..... 18-8136-004

3 Lichtscheibe | lens
(a) links mit 18-8440-001
left with
rechts mit 18-8442-001
right with
(b) links mit für 18-8440-051
left with for
rechts mit 18-8442-101
right with

5 ASS1 & ASS2 Verbinder |
ASS1 & ASS2 connector
7 pol. weiblich
7 pin female 13-5626-631

Glühlampe | bulb
24V 21W 16-6321-037
24V 21/5W 16-6322-027
24V 10W 16-6310-027
24V 5W Soffitte 16-6705-017
24V 4W 16-6304-027



MULTILED II hoch / high

ADR Zone 2 IP 6K9K

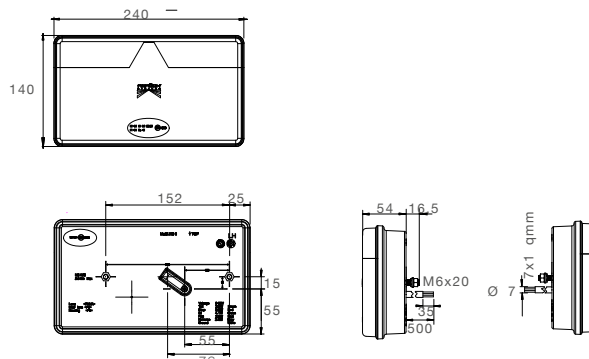

Blinklicht Direction indicator	Rücklicht Tail light	Bremslicht Stop light	Nebelschlusslicht Fog light
Rückfahrlicht Reverse light	Dreieckrückstrahler Triangle reflector		

BEST. NR							ZUSATZ	ANSCHLUSS
PART NO							ADD ON	CONNECTOR
35-0203-001	1/-	●		LED	12V 24V			offenes Ende open end 0,50 m
35-0203-011	1/-	●		LED	12V 24V			5 pol. Bajonett 5 pin Bayonet 0,50 m
35-0203-021	1/-	●		LED	12V 24V			8 pol. Bajonett 8 pin Bayonet 0,50 m
35-0203-031	1/-	●		LED	12V 24V			7 pol. ASS2 7 pin ASS2 0,50 m
35-0203-041	1/-	●		LED	12V 24V			7 pol. AMP 7 pin AMP 0,50 m
35-0203-051	1/-	●		LED	12V 24V			offenes Ende open end 0,50 m
35-0203-061	1/-	●		LED	12V 24V			5 pol. Bajonett 5 pin Bayonet 0,50 m
35-0203-071	1/-	●		LED	12V 24V			8 pol. Bajonett 8 pin Bayonet 0,50 m
35-0203-081	1/-	●		LED	12V 24V			7 pol. ASS2 7 pin ASS2 0,50 m
35-0203-091	1/-	●		LED	12V 24V			7 pol. AMP 7 pin AMP 0,50 m
35-0203-101	1/-	●		LED	12V 24V			offenes Ende open end 0,50 m
35-0203-111	1/-	●		LED	12V 24V			5 pol. Bajonett 5 pin Bayonet 0,50 m
35-0203-121	1/-	●		LED	12V 24V			8 pol. Bajonett 8 pin Bayonet 0,50 m
35-0203-131	1/-	●		LED	12V 24V			7 pol. ASS2 7 pin ASS2 0,50 m
35-0203-141	1/-	●		LED	12V 24V			7 pol. AMP 7 pin AMP 0,50 m



MULTILED II hoch / high

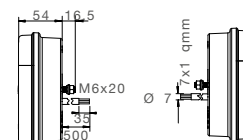
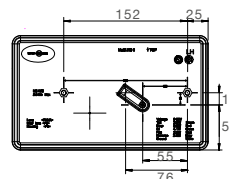
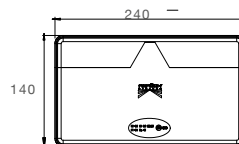

Blinklicht Direction indicator	Rücklicht Tail light	Bremslicht Stop light	Nebelschlusslicht Fog light
Rückfahrlicht Reverse light	Dreieckrückstrahler Triangle reflector		

BEST. NR							ZUSATZ	ANSCHLUSS	
PART NO							ADD ON	CONNECTOR	
35-0204-001	1/-		●	LED	12V 24V			offenes Ende open end	0,50 m
35-0204-011	1/-		●	LED	12V 24V			5 pol. Bajonett 5 pin Bayonet	♂ 0,50 m
35-0204-021	1/-		●	LED	12V 24V			8 pol. Bajonett 8 pin Bayonet	♂ 0,50 m
35-0204-051	1/-		●	LED	12V 24V			offenes Ende open end	0,50 m
35-0204-031	1/-		●	LED	12V 24V			7 pol. ASS2 7 pin ASS2	♂ 0,50 m
35-0204-041	1/-		●	LED	12V 24V			7 pol. AMP 7 pin AMP	♂ 0,50 m
35-0204-061	1/-		●	LED	12V 24V			5 pol. Bajonett 5 pin Bayonet	♂ 0,50 m
35-0204-071	1/-		●	LED	12V 24V			8 pol. Bajonett 8 pin Bayonet	♂ 0,50 m
35-0204-081	1/-		●	LED	12V 24V			7 pol. ASS2 7 pin ASS2	♂ 0,50 m
35-0204-091	1/-		●	LED	12V 24V			7 pol. AMP 7 pin AMP	♂ 0,50 m
35-0204-101	1/-		●	LED	12V 24V			offenes Ende open end	0,50 m
35-0204-111	1/-		●	LED	12V 24V			5 pol. Bajonett 5 pin Bayonet	♂ 0,50 m
35-0204-121	1/-		●	LED	12V 24V			8 pol. Bajonett 8 pin Bayonet	♂ 0,50 m
35-0204-131	1/-		●	LED	12V 24V			7 pol. ASS2 7 pin ASS2	♂ 0,50 m
35-0204-141	1/-		●	LED	12V 24V			7 pol. AMP 7 pin AMP	♂ 0,50 m



MULTILED II flach / flat

ADR Zone 2 IP6K9K

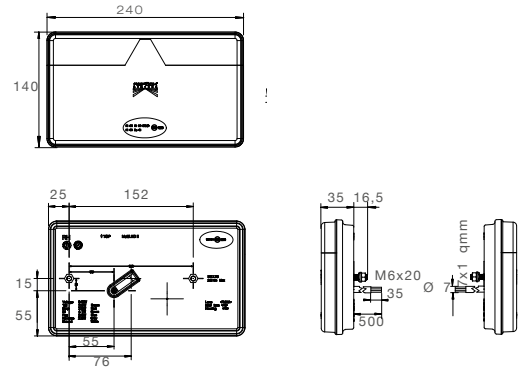

Blinklicht Direction indicator	Rücklicht Tail light	Bremslicht Stop light	Nebelschlusslicht Fog light
Rückfahrlicht Reverse light	Dreieckrückstrahler Triangle reflector		

BEST. NR	PART NO	Box	←	→	LED	V	ZUSATZ	ANSCHLUSS
							ADD ON	CONNECTOR
35-0201-001	1/-	●			LED	12V 24V		offenes Ende open end 0,50 m
35-0201-011	1/-	●			LED	12V 24V		5 pol. Bajonett 5 pin Bayonet ♂ 0,50 m
35-0201-021	1/-	●			LED	12V 24V		8 pol. Bajonett 8 pin Bayonet ♂ 0,50 m
35-0201-031	1/-	●			LED	12V 24V		7 pol. ASS2 7 pin ASS2 ♂ 0,50 m
35-0201-041	1/-	●	●		LED	12V 24V		7 pol. AMP 7 pin AMP ♂ 0,50 m
35-0202-001	1/-		●		LED	12V 24V		offenes Ende open end 0,50 m
35-0202-011	1/-		●		LED	12V 24V		5 pol. Bajonett 5 pin Bayonet ♂ 0,50 m
35-0202-021	1/-		●		LED	12V 24V		8 pol. Bajonett 8 pin Bayonet ♂ 0,50 m
35-0202-031	1/-		●		LED	12V 24V		7 pol. ASS2 7 pin ASS2 ♂ 0,50 m
35-0202-041	1/-		●		LED	12V 24V		7 pol. AMP 7 pin AMP ♂ 0,50 m



MULTILED II

ZUBEHÖHR / ACCESSORIES

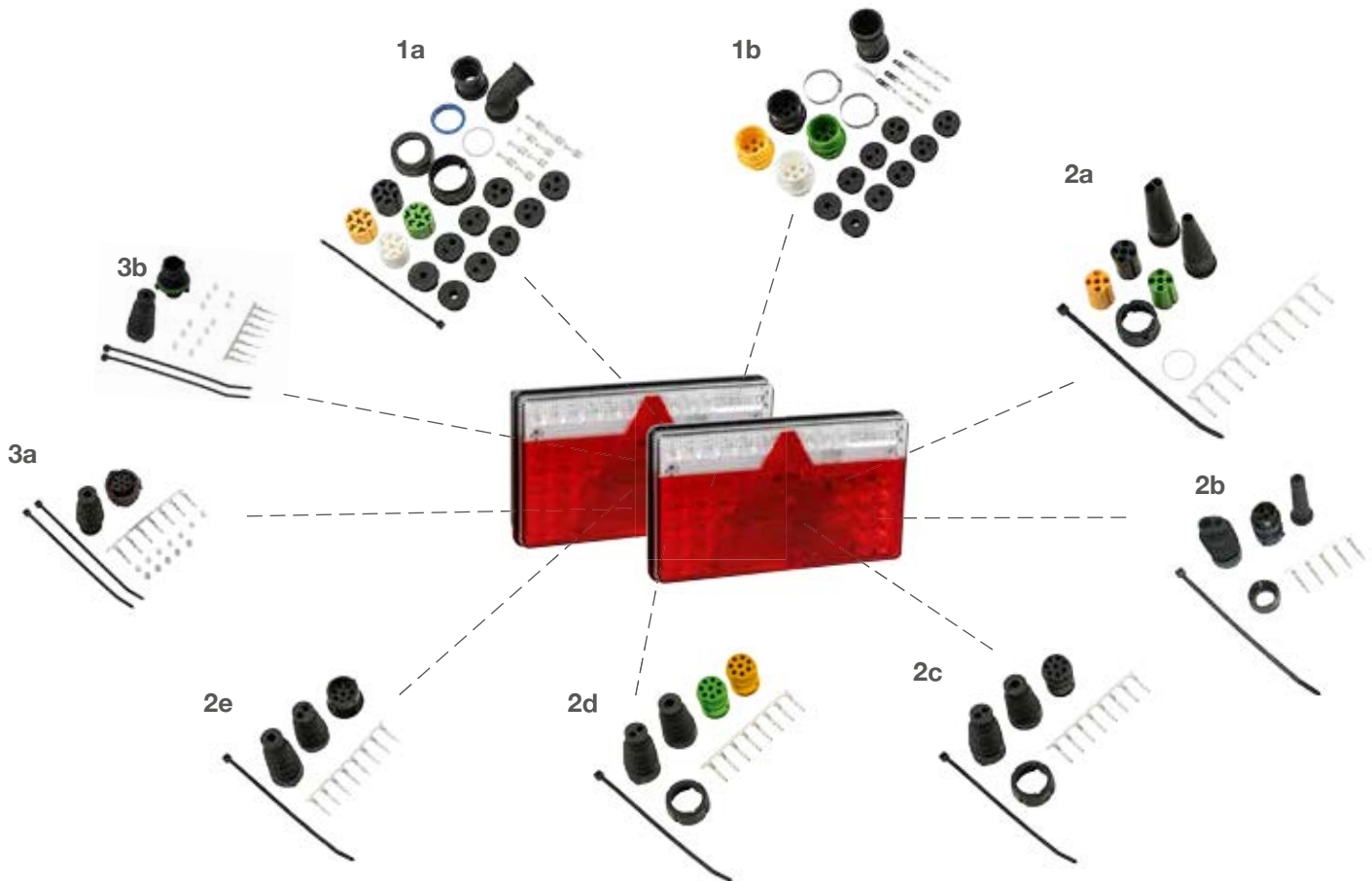

1 ASS1 & ASS2 Verbinder | ASS1 & ASS2 connector

- (a) 7 pol. weiblich
7 pin female 13-5626-631
- (b) 7 pol. männlich
7 pin male 13-5625-981

2 Bajonett Verbinder | bayonet connector

- (a) 5 pol. weiblich
5 pin female 13-0521-104
- (b) 5 pol. männlich
5 pol. male 13-0536-044
- (c) 8 pol. weiblich
8 pin female 13-0828-034
- (d) 8 pol. weiblich
8 pin female 15-0821-524
- (e) 8 pol. männlich
8 pol. male 13-0838-054

3 AMP Verbinder | AMP connector

- (a) 7 pol. weiblich
7 pin female 15-7002-024
- (b) 7 pol. männlich
7 pin male 15-7002-034



MULTILED

ADR Zone 2 IP69K

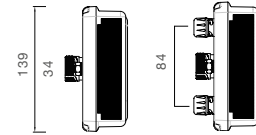
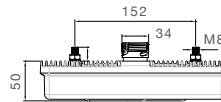
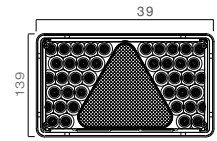

Blinklicht Direction indicator	Rücklicht Tail light	Bremslicht Stop light	Nebelschlusslicht Fog light
Rückfahrlicht Reverse light	Dreieckrückstrahler Triangle reflector	Seitenmarkierungslicht + Reflektor Sidemarker light + reflector	

BEST. NR	PART NO		←	→			ZUSATZ ADD ON	ANSCHLUSS CONNECTOR
24-7400-701	1/-	●			24V		7 pol. ASS2.1 7 pin ASS2.1	♂
24-7430-701	1/-	●			24V		7 pol. AMP 7 pin AMP	♂ 1 x 2 pol. ASS2 1 x 2 pin ASS2
24-7470-701	1/-	●			24V		7 pol. AMP 7 pin AMP	♂ 1 x 2 pol. ASS2 1 x 2 pin ASS2
24-7630-701	1/-	●			24V	Plastikgehäuse plastic housing	7 pol. AMP 7 pin AMP	♂ 1 x 2 pol. ASS2 1 x 2 pin ASS2
24-7500-701	1/-		●		24V		7 pol. ASS2.1 7 pin ASS2.1	♂
24-7530-701	1/-		●		24V		7 pol. AMP 7 pin AMP	♂ 1 x 2 pol. ASS2 1 x 2 pin ASS2
24-7570-701	1/-		●		24V		7 pol. AMP 7 pin AMP	♂ 1 x 2 pol. ASS2 1 x 2 pin ASS2
24-7730-701	1/-		●		24V	Plastikgehäuse plastic housing	7 pol. AMP 7 pin AMP	♂ 1 x 2 pol. ASS2 1 x 2 pin ASS2



MULTILED

ZUBEHÖHR / ACCESSORIES

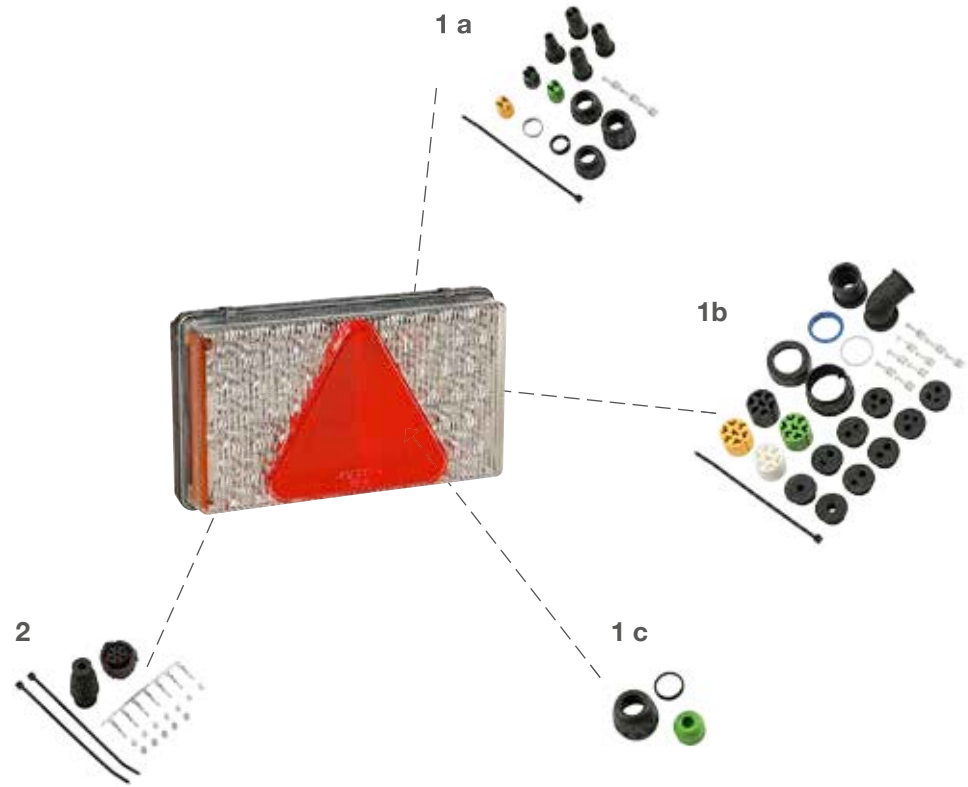

1 ASS1 & ASS2 Verbinder | ASS1 & ASS2 connector

- (a) 2 pol. weiblich
2 pin female 13-5626-401
- (b) 7 pol. weiblich
7 pin female 13-5626-631
- (c) Verschlusskappe
closed connection 15-5623-304

2 AMP Verbinder | AMP connector

- 7 pol. weiblich
- 7 pin female 15-7002-024

LED Vorschaltgerät | LED control gear

- LCG siehe Seite 166
- see at page 166



MULTIPOINT V

ADR Zone 2

IP 54

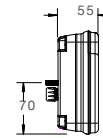
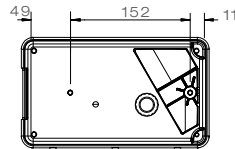
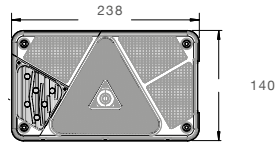

Blinklicht Direction indicator	Rücklicht Tail light	Bremslicht Stop light	Nebelschlusslicht Fog light
Rückfahrlicht Reverse light			

BEST. NR	PART NO							ZUSATZ ADD ON	ANSCHLUSS CONNECTOR
24-8502-001	1/-	●			24V			PG Verschraubung cable glands	
24-8504-701	1/-	●			24V			PG Verschraubung cable glands	
34-8503-001	1/-	●			24V			7 pol. AMP 7 pin AMP	0,15 m
34-8505-001	1/-	●			24V			7 pol. ASS2 7 pin ASS2	2,50 m
34-8605-001	1/-	●			24V			7 pol. ASS2 7 pin ASS2	0,90 m
24-8702-001	1/-		●		24V			PG Verschraubung cable glands	
24-8714-701	1/-		●		24V			PG Verschraubung cable glands	
34-8702-001	1/-		●		24V			7 pol. AMP 7 pin AMP	0,15 m
34-8706-001	1/-		●		24V			7 pol. ASS2 7 pin ASS2	2,50 m
34-8806-001	1/-		●		24V			7 pol. ASS2 7 pin ASS2	0,90 m



MULTIPOINT V

ZUBEHÖHR / ACCESSORIES

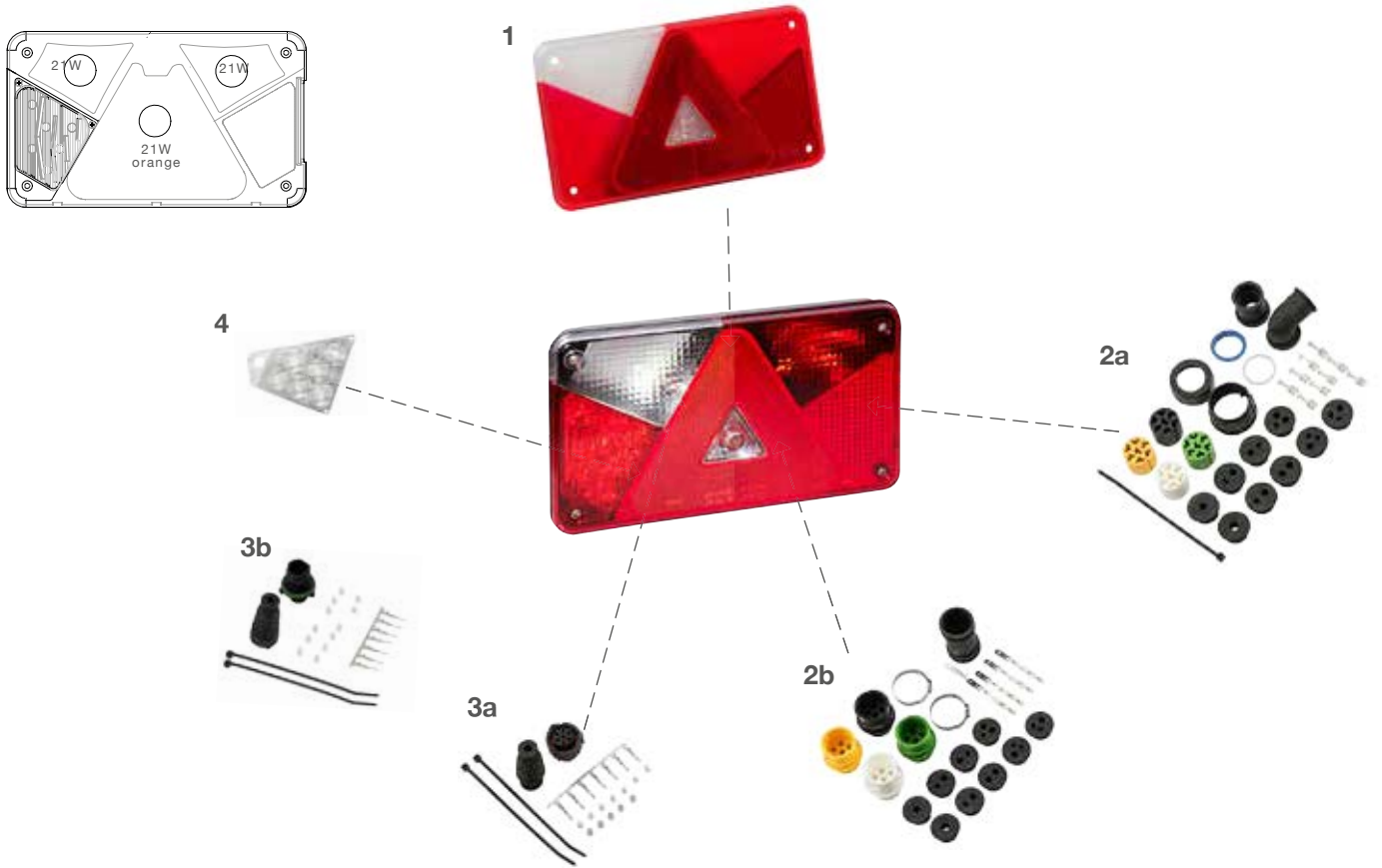

1 Lichtscheibe | lens

- links
left..... 18-8485-004
- rechts
right 18-8487-004

2 ASS1 & ASS2 Verbinder | ASS1 & ASS2 connector

- (a) 7 pol. weiblich
7 pin female 13-5626-631
- (b) 7 pol. männlich
7 pin male 13-5625-981

3 AMP Verbinder | AMP connector

- (a) 7 pol. weiblich
7 pin female 15-7002-024
- (b) 7 pol. männlich
7 pin male 15-7002-034

4 LED Einsätze | LED insert

- Rücklicht / Bremslicht links
tail light / stop light left
..... 12-1530-004
- Rücklicht / Bremslicht rechts
tail light / stop light right
..... 12-1531-004

Glühlampe | bulb

- 24V 21W orange 16-6321-617
- 24V 21W 16-6321-037
- 24V 10W 16-6310-027



MULTIPOINT LED

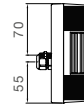
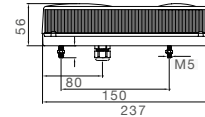
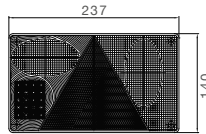

Blinklicht Direction indicator	Rücklicht Tail light	Bremslicht Stop light	
		Seitenmarkierungslicht + Reflektor Sidemarker light + reflector	

BEST. NR		←	→	💡	⚡	🔦	ZUSATZ	ANSCHLUSS
PART NO							ADD ON	CONNECTOR
24-5700-721	1/-	●			24V			PG 11 Verschraubung cable glands 11
24-5705-701	1/-	●			24V			PG 11 Verschraubung cable glands 11
34-5703-001	1/-	●			24V			8 pol. Bajonett 8 pin Bayonet 1,80 m
34-5703-011	1/-	●			24V			8 pol. Bajonett 8 pin Bayonet 1,80 m
34-5705-001	1/-	●			24V			7 pol. ASS2 7 pin ASS2 2,50 m
24-5800-731	1/-		●		24V			PG 11 Verschraubung cable glands 11
24-5805-701	1/-		●		24V			PG 11 Verschraubung cable glands 11
24-5805-711	1/-		●		24V			Tülleneingang grommet
24-5813-701	1/-		●		24V			Tülleneingang grommet
34-5802-001	1/-		●		24V			8 pol. Bajonett 8 pin Bayonet 1,80 m
34-5802-011	1/-		●		24V			8 pol. Bajonett 8 pin Bayonet 2,50 m
34-5806-001	1/-		●		24V			7 pol. ASS2 7 pin ASS2 2,50 m



MULTIPOINT LED

ZUBEHÖHR / ACCESSORIES

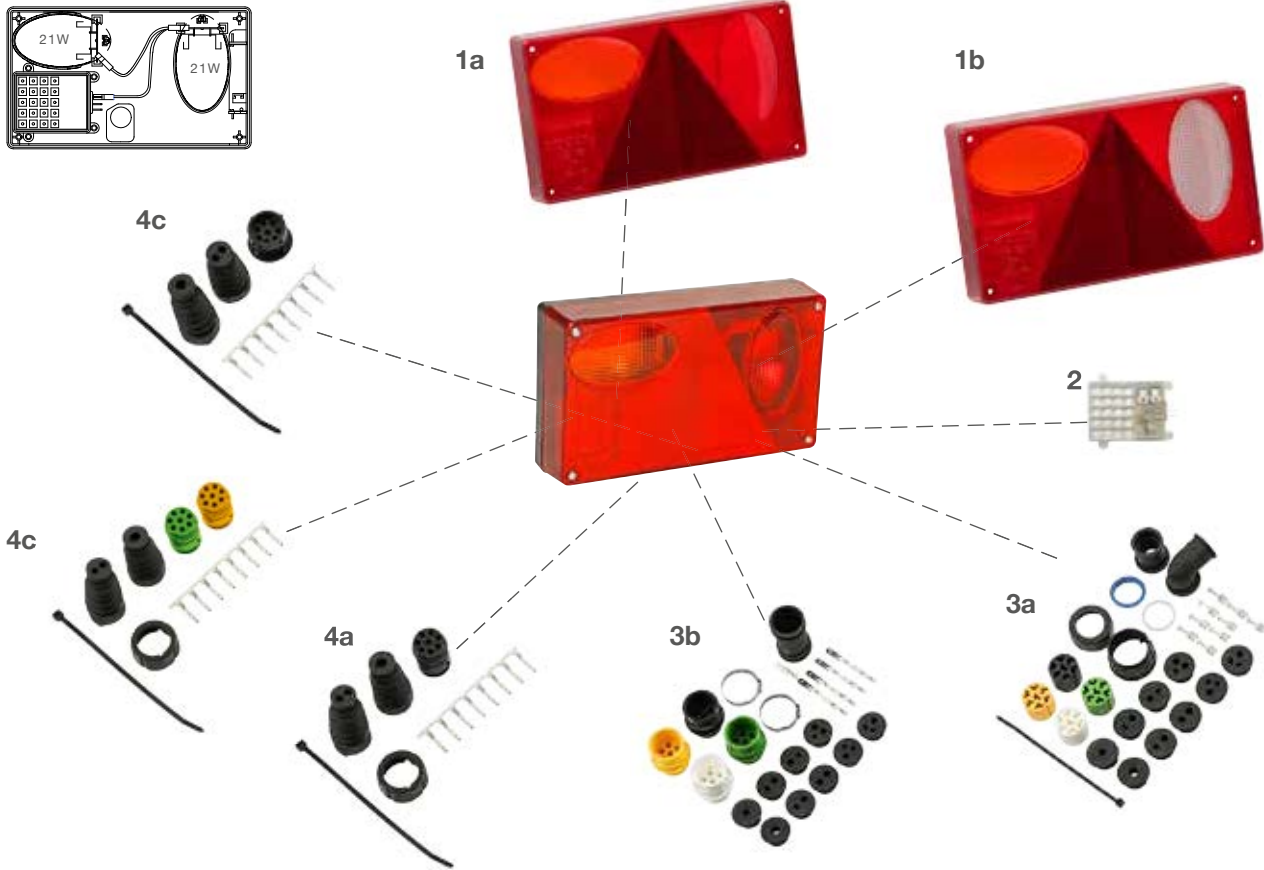

1 Lichtscheibe | lens

- (a) links mit left with 18-8457-131
- rechts mit right with 18-8458-051
- (b) links mit für left with for 18-8457-051
- rechts mit right with 18-8458-131

2 LED Einsätze | LED inserts

- 12-1527-004

3 ASS1 & ASS2 Verbinder | ASS1 & ASS2 connector

- (a) 7 pol. weiblich
7 pin female 13-5626-631
- (b) 7 pol. männlich
7 pin male 13-5625-981

4 Bajonett Verbinder | bayonet connector

- (a) 8 pol. weiblich
8 pin female 13-0828-034
- (b) 8 pol. weiblich
8 pin female 15-0821-524
- (c) 8 pol. männlich
8 pin male 13-0838-054

Glühlampe | bulb

- 24V 21W 16-6321-037



MULTIPOINT I

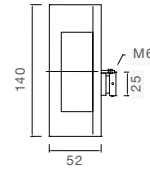
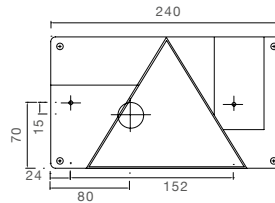

Blinklicht Direction indicator	Rücklicht Tail light	Bremslicht Stop light	

BEST. NR							ZUSATZ	ANSCHLUSS
PART NO							ADD ON	CONNECTOR
24-5000-011	1/-	●			24V			5 pol. Bajonett 5 pin Bayonet
24-5000-521	1/-	●			24V			5 pol. Bajonett 5 pin Bayonet
24-5000-531	1/-	●			24V			8 pol. Bajonett 8 pin Bayonet
24-5013-001	1/-	●			24V			PG 11 Verschraubung cable glands 11
24-5200-011	1/-		●		24V			5 pol. Bajonett 5 pin Bayonet
24-5200-521	1/-		●		24V			5 pol. Bajonett 5 pin Bayonet
24-5210-011	1/-		●		24V			5 pol. Bajonett 5 pin Bayonet
24-5211-511	1/-		●		24V			5 pol. Bajonett 5 pin Bayonet
24-5211-521	1/-		●		24V			8 pol. Bajonett 8 pin Bayonet
24-5213-001	1/-		●		24V			PG 11 Verschraubung cable glands 11







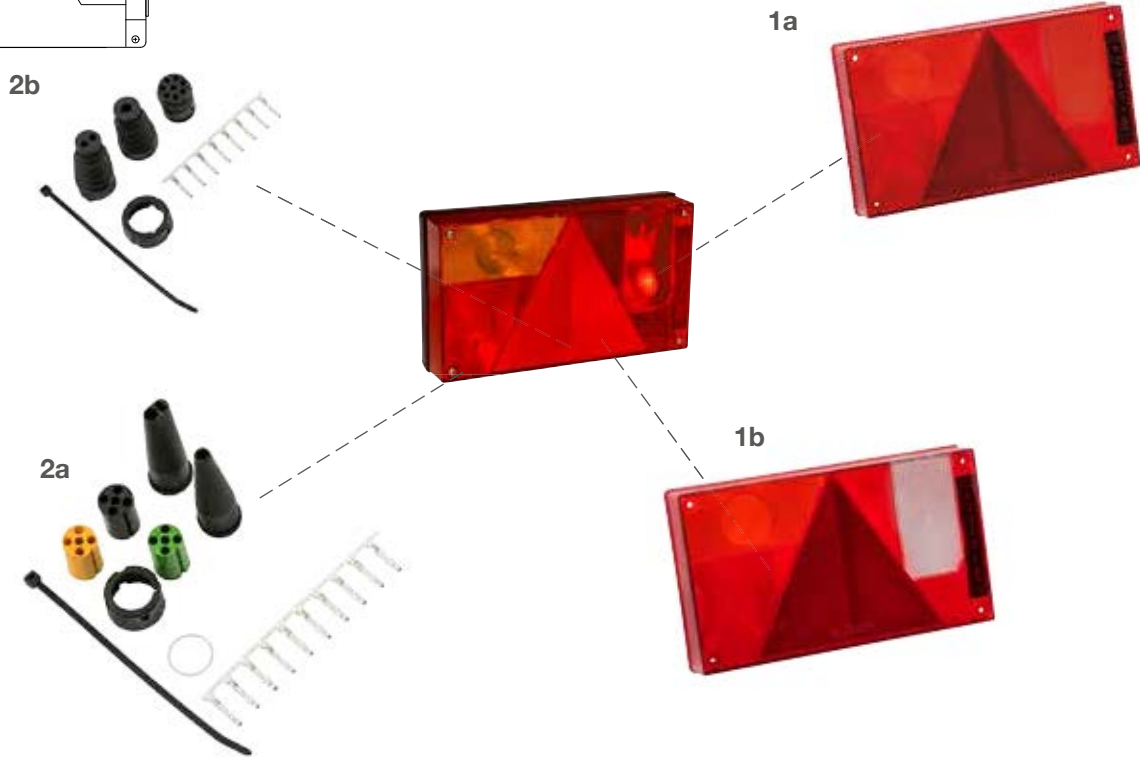
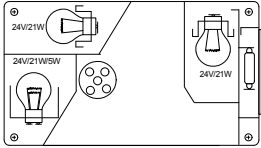





MULTIPOINT I

ZUBEHÖHR / ACCESSORIES



1 Lichtscheibe | lens

- (a) links mit 
 - left with  18-8450-021 
 - rechts mit 
 - right with  18-8452-021 
- (b) links mit 
 - left with  18-8451-021 
 - rechts mit 
 - right with  18-8452-121 

2 Bajonett Verbinder | bayonet connector

- (a) 5 pol. weiblich
 - 5 pin female 13-0521-104 
- (b) 8 pol. weiblich
 - 8 pin female 13-0828-034 

Glühlampe | bulb

- 24V 21W 16-6321-037 
- 24V 21/5W 16-6310-027 
- 24V 5W Soffitte 16-6705-017 



MINILED II

ADR Zone 2 IP 6K9K

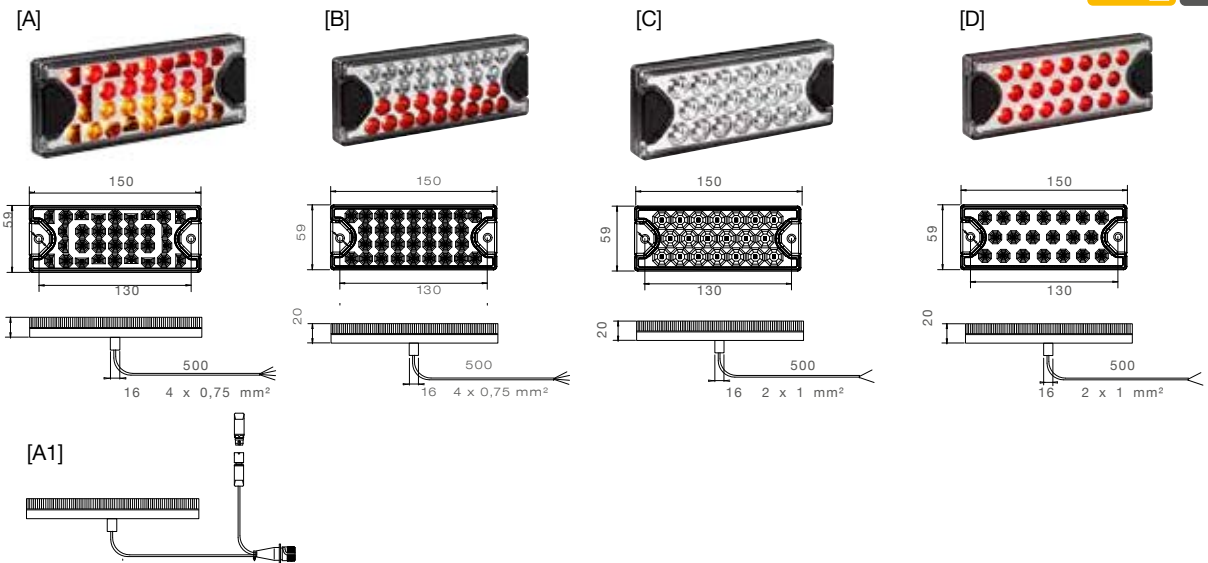

BEST. NR							ZUSATZ	ANSCHLUSS
PART NO							ADD ON	CONNECTOR
32-7200-001	1/-			LED	12V 24V	[B]		offenes Ende open end 0,50 m
32-7207-001	1/-			LED	12V 24V	[B]		3 pol. ASS3 3 pin ASS3 0,50 m
33-7200-001	1/-			LED	12V 24V	[A]		offenes Ende open end 0,50 m
33-7200-011	1/-			LED	12V 24V	[A]		offenes Ende open end 5,00 m
33-7207-041	1/-	●		LED	12V 24V	[A1]		7 pol. ASS2 7 pin ASS2 0,50 m
								3 pol. ASS3 3 pin ASS3 0,25 m
33-7207-051	1/-	●		LED	12V 24V	[A1]		7 pol. ASS2 7 pin ASS2 0,50 m
								3 pol. ASS3 3 pin ASS3 0,25 m
37-7200-001	1/-			LED	12V 24V	[D]		offenes Ende open end 0,50 m
37-7207-001				LED	12V 24V	[D]		2 pol. ASS3 2 pin ASS3 0,50 m
38-7200-001	1/-			LED	12V 24V	[C]		offenes Ende open end 0,50 m
38-7207-001				LED	12V 24V	[C]		2 pol. ASS3 2 pin ASS3 0,50 m



MINILED II

ZUBEHÖHR / ACCESSORIES

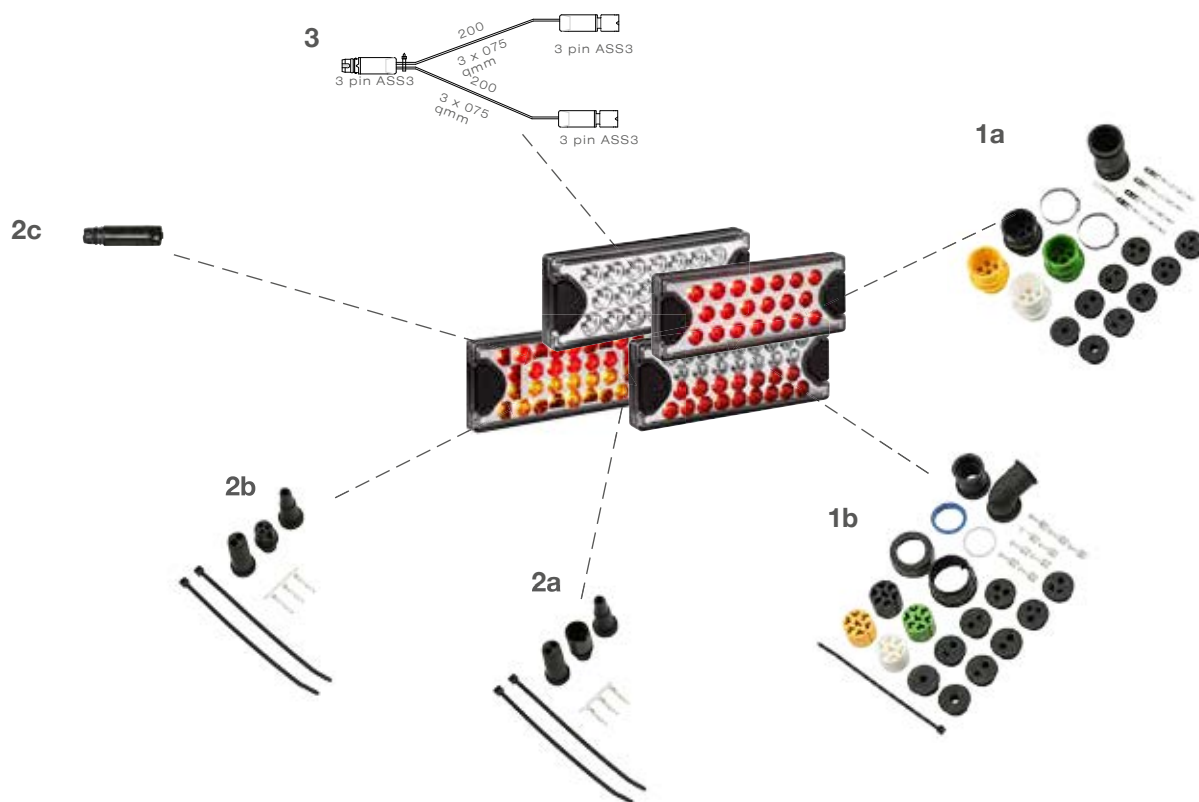

- 1 ASS1 & ASS2 Verbinder | ASS1 & ASS2 connector**
- (a) 7 pol. männlich
7 pin male 13-5625-981
 - (b) 7 pol. weiblich
7 pin female 13-5626-631
- 2 ASS3 Verbinder | ASS3 connector**
- (a) 3 pol. männlich
3 pin male 13-0332-281
 - (b) 3 pol. weiblich
3 pin female 13-0322-281
 - (c) 3 pol. Verschlusskappe
3 pin connection 13-0320-004
- 3 Y-Kabel 3 pol. ASS3 | Y-cable 3 pin ASS3**
- 65-6502-014



LINEPOINT II

ADR Zone 2 IP6K9K

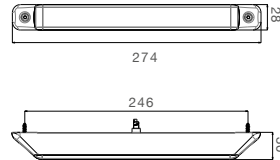

BEST. NR							ZUSATZ	ANSCHLUSS
PART NO							ADD ON	CONNECTOR
31-9207-031	-/-	●		LED	12V 24V			2 pol. ASS3 2 pin ASS3 ♀ 0,50 m
31-9207-071	-/-	●		LED	12V 24V			2 pol. ASS3 2 pin ASS3 ♀ 0,25 m
31-9231-201	1/-	●		LED	12V 24V			offenes Ende open end 0,50 m
31-9207-021	-/-		●	LED	12V 24V			2 pol. ASS3 2 pin ASS3 ♀ 0,50 m
31-9207-061	-/-		●	LED	12V 24V			2 pol. ASS3 2 pin ASS3 ♀ 0,25 m
31-9231-211	1/-		●	LED	12V 24V			offenes Ende open end 0,50 m
31-9207-011	1/-	●	●	LED	12V 24V			3 pol. ASS3 3 pin ASS3 ♀ 0,50 m
31-9231-001	1/-	●	●	LED	12V 24V			offenes Ende open end 0,50 m
31-9207-001	1/-	●	●	LED	12V 24V			3 pol. ASS3 3 pin ASS3 ♀ 0,50 m
31-9230-001	1/-	●	●	LED	12V 24V			offenes Ende open end 0,50 m
31-9207-081	-/-	●	●	LED	12V 24V			3 pol. ASS3 3 pin ASS3 ♀ 0,25 m
37-9207-001	1/-	●	●	LED	12V 24V			3 pol. ASS3 3 pin ASS3 ♀ 0,50 m
37-9230-001	1/-	●	●	LED	12V 24V			offenes Ende open end 0,50 m
38-9207-001	1/-	●	●	LED	12V 24V			3 pol. ASS3 3 pin ASS3 ♀ 0,50 m
38-9230-001	1/-	●	●	LED	12V 24V			offenes Ende open end 0,50 m
38-9231-001	1/-	●	●	LED	12V 24V			offenes Ende open end 0,50 m
38-9237-001	1/-	●	●	LED	12V 24V			3 pol. ASS3 3 pin ASS3 ♀ 0,50 m
38-9207-021	-/-	●	●	LED	12V 24V			3 pol. ASS3 3 pin ASS3 ♀ 0,25 m



LINEPOINT II

ZUBEHÖHR / ACCESSORIES

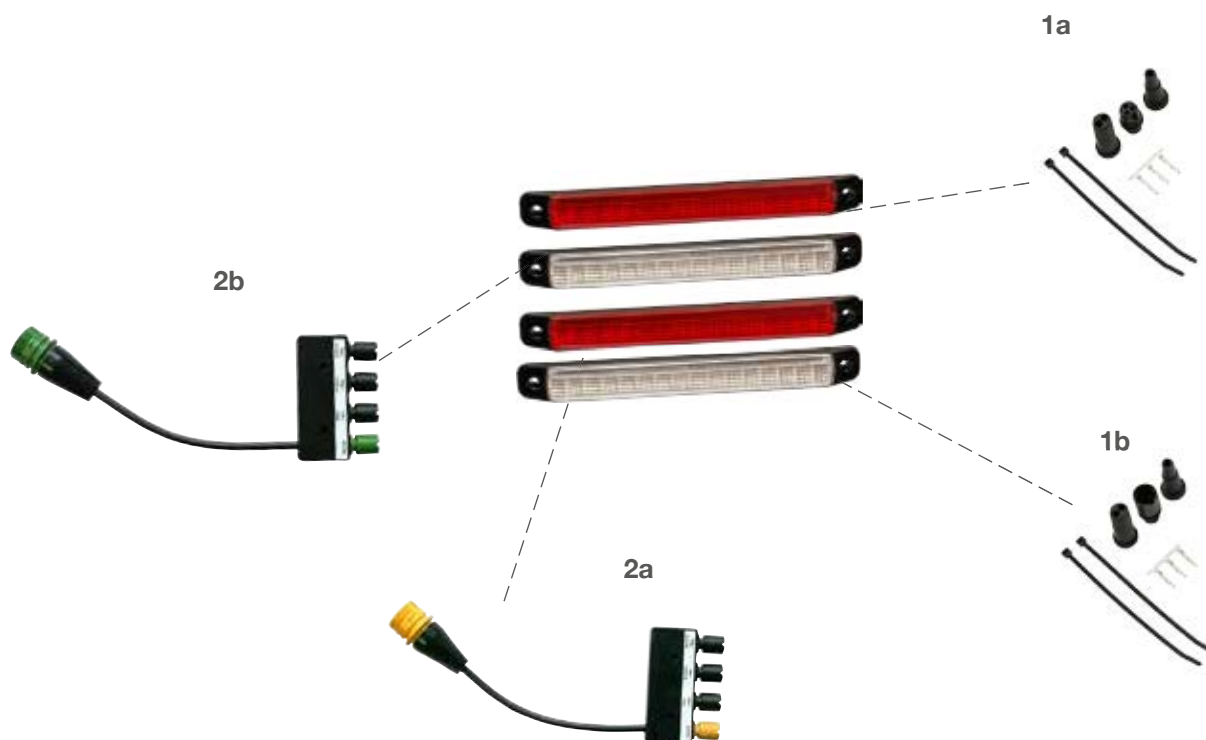

1 ASS3 Verbinder | ASS3 connector

- (a) 3 pol. weiblich
3 pin female 13-0322-281
- (b) 3 pol. männlich
3 pin male 13-0332-281

2 ASS3 Verteiler | ASS3 junction box

- (a) links
left 76-9027-001
- (b) rechts
right 76-9028-001



LINEPOINT I

ADR Zone 2 IP6K9K

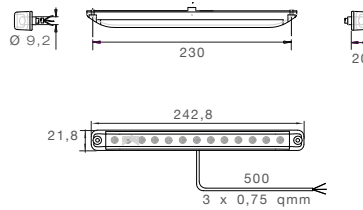

BEST. NR		←	→	💡	⚡	⚙️	ZUSATZ	ANSCHLUSS
PART NO	📦						ADD ON	CONNECTOR
31-8920-001	1/-	●	●	LED	12V 24V		⊕ ⊖ ↔ ↕	offenes Ende 2 pol. open end 2 pin 0,50 m ↗
31-8927-001	-/-	●	●	LED	12V 24V		⊕ ⊖ ↔ ↕	2 pol. ASS3 2 pin ASS3 ♀ ♂ 0,50 m ↗
31-9207-041	1/-	●	●	LED	12V 24V		↔ ↕ ⊕ ⊖	3 pol. ASS3 3 pin ASS3 ♀ ♂ 0,50 m ↗
31-9207-051	1/-	●	●	LED	12V 24V		↔ ↕ ⊕ ⊖	2 pol. ASS3 2 pin ASS3 ♀ ♂ 0,50 m ↗
31-9220-001	1/-	●	●	LED	12V 24V		↔ ↕ ⊕ ⊖	offenes Ende 3 pol. open end 3 pin 0,50 m ↗
31-9220-011	-/-	●	●	LED	12V 24V		↔ ↕ ⊕ ⊖	3 pol. AMP 3 pin AMP ♂ 0,15 m ↗
31-9221-001	1/-	●	●	LED	12V 24V		↔ ↕ ⊕ ⊖	offenes Ende 2 pol. open end 2 pin 0,50 m ↗
31-9221-011	-/-	●	●	LED	12V 24V		↔ ↕ ⊕ ⊖	2 pol. Superseal 2 pin Superseal ♂ 0,15 m ↗
37-9207-011	-/-	●	●	LED	12V 24V		↔ ↕ ⊕ ⊖	3 pol. ASS3 3 pin ASS3 ♀ ♂ 0,50 m ↗
37-9220-001	1/-	●	●	LED	12V 24V		↔ ↕ ⊕ ⊖	offenes Ende 2 pol. open end 2 pin 0,50 m ↗
37-9220-011	-/-	●	●	LED	12V 24V		↔ ↕ ⊕ ⊖	2 pol. Superseal 2 pin Superseal ♂ 0,15 m ↗
38-9207-011	1/-	●	●	LED	12V 24V		↔ ↕ ⊕ ⊖	2 pol. ASS3 2 pin ASS3 ♀ ♂ 0,50 m ↗
38-9220-001	1/-	●	●	LED	12V 24V		↔ ↕ ⊕ ⊖	offenes Ende 2 pol. open end 2 pin 0,50 m ↗
38-9220-011	-/-	●	●	LED	12V 24V		↔ ↕ ⊕ ⊖	2 pol. Superseal 2 pin Superseal ♂ 0,15 m ↗
33-8914-001	1/-	●	●	LED	12V 24V		↔ ↕ ⊕ ⊖	offenes Ende open end 0,50 m ↗
33-8914-014	1/-	●	●	LED	12V 24V		↔ ↕ ⊕ ⊖	offenes Ende open end 5,00 m ↗



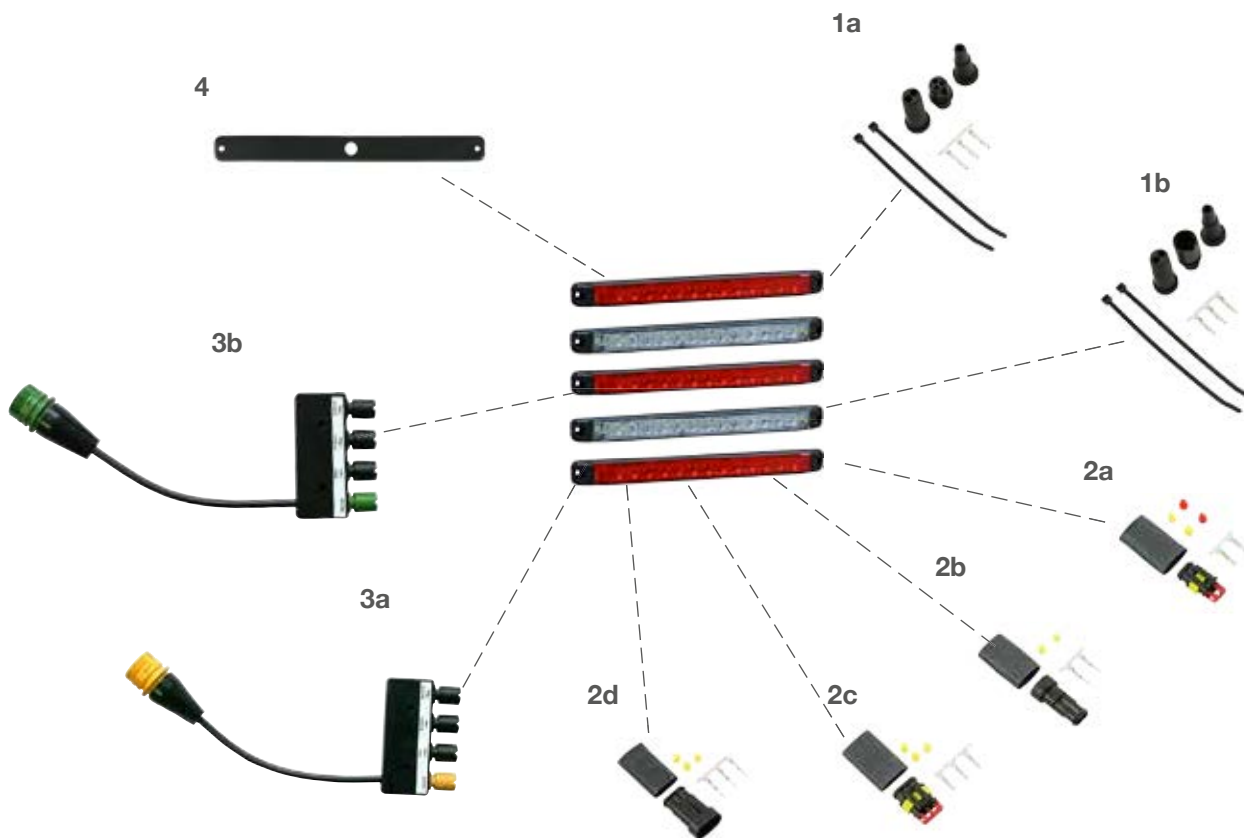

LINEPOINT I

ZUBEHÖHR / ACCESSORIES



1 ASS3 Verbinder | ASS3 connector

- (a) 3 pol. weiblich
3 pin female 13-0322-281 
- (b) 3 pol. männlich
3 pin male 13-0332-281 

2 Superseal Verbinder | Superseal connector

- (a) 2 pol. weiblich
2 pin female 15-7002-044
- (b) 2 pol. männlich
2 pin male 15-7002-054
- (c) 3 pol. weiblich
3 pin female 15-7002-064
- (d) 3 pol. männlich
3 pin male 15-7002-074

3 ASS3 Verteiler | ASS3 junction box

- (a) links
left 76-9027-001 
- (b) rechts
right 76-9028-001 

4 Gummiunterlage | rubber pad

- 15-5111-404 







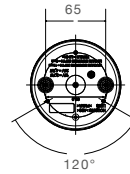
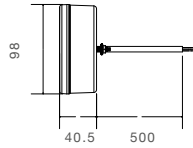





























BRASPOINT 98

ADR Zone 2 IP 6K9K



 Rückfahrlicht Reverse light	 Rücklicht Tail light	 Nebelschlusslicht Fog light
	 Rückstrahler rot Reflector red	

BEST. NR		←	→				ZUSATZ	ANSCHLUSS
PART NO							ADD ON	CONNECTOR
33-8100-001	1/-	●	●	LED	12V 24V			offenes Ende open end 0,50 m 
33-8100-101	1/-	●	●	LED	12V 24V			offenes Ende open end 0,50 m 
33-8100-501	1/-	●	●	LED	12V 24V			8 pol. Bajonett 8 pin Bayonet   0,50 m 
33-8100-601	1/-	●	●	LED	12V 24V			8 pol. Bajonett 8 pin Bayonet   0,50 m 
33-8107-041	1/-	●	●	LED	12V 24V			7 pol. ASS2 7 pin ASS2   0,50 m 
33-8107-051	1/-	●	●	LED	12V 24V			7 pol. ASS2 7 pin ASS2   0,50 m 
33-8180-001	1/-	●	●	LED	12V 24V			4 pol. AMP 4 pin AMP   0,50 m 



BRASPOINT 98

ADR Zone 2 IP6K9K

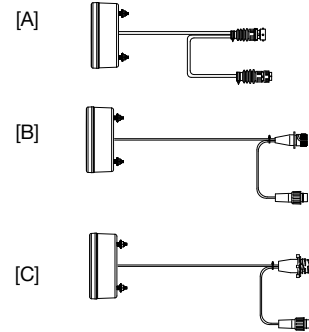
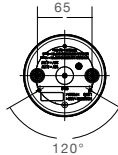
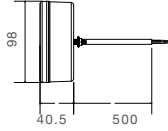

Blinklicht Direction indicator	Rücklicht Tail light	Bremslicht Stop light	

BEST. NR		←	→				ZUSATZ	ANSCHLUSS
PART NO							ADD ON	CONNECTOR
33-9200-001	1/-	●	●	LED	12V 24V			offenes Ende open end 0,50 m
33-9200-011	1/-	●	●	LED	12V 24V			offenes Ende open end 7,00 m
33-9200-021	1/-	●	●	LED	12V 24V			offenes Ende open end 2,00 m
33-9200-501	1/-	●	●	LED	12V 24V			5 pol. Bajonett 5 pin Bayonet 0,50 m
33-9200-511	1/-	●	●	LED	12V 24V		[A]	8 pol. Bajonett 8 pin Bayonet 0,50 m
								8 pol. Bajonett 8 pin Bayonet 0,25 m
33-9207-051	1/-	●	●	LED	12V 24V		[B]	7 pol. ASS2 7 pin ASS2 0,50 m
								7 pol. ASS2 7 pin ASS2 0,20 m
33-9207-081	1/-	●	●	LED	12V 24V		[C]	7 pol. AMP 7 pin AMP 0,50 m
								7 pol. ASS2 7 pin ASS2 0,20 m
33-9280-001	1/-	●	●	LED	12V 24V			4 pol. AMP 4 pin AMP 0,50 m



BRASPOINT 98

ZUBEHÖHR / ACCESSORIES

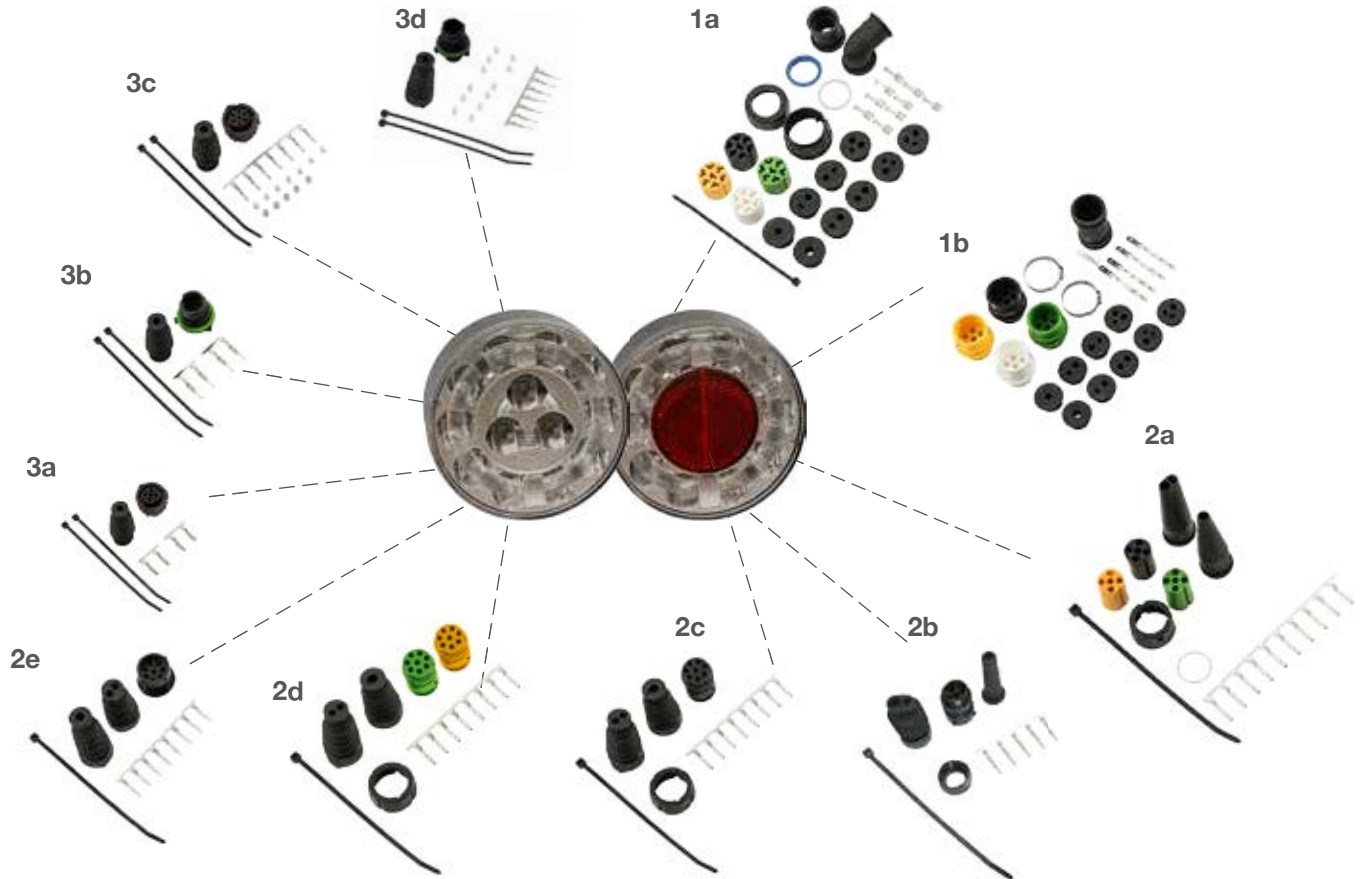

1 ASS1 & ASS2 Verbinder | ASS1 & ASS2 connector

- (a) 7 pol. weiblich
7 pin female 13-5626-631
- (b) 7 pol. männlich
7 pin male 13-5625-981

2 Bajonett Verbinder | bayonet connector

- (a) 5 pol. weiblich
5 pin female 13-0521-104
- (b) 5 pol. männlich
5 pin male 13-0536-044
- (c) 8 pol. weiblich
8 pin female 13-0828-034
- (d) 8 pol. weiblich
8 pin female 15-0821-524
- (e) 8 pol. männlich
8 pin male 13-0838-054

3 AMP Verbinder | AMP connector

- (a) 4 pol. weiblich
4 pin female 15-7002-004
- (b) 4 pol. männlich
4 pin male 15-7002-014
- (c) 7 pol. weiblich
7 pin female 15-7002-024
- (d) 7 pol. männlich
7 pin male 15-7002-034



BRASPOINT 140

ADR Zone 2 IP 6K9K

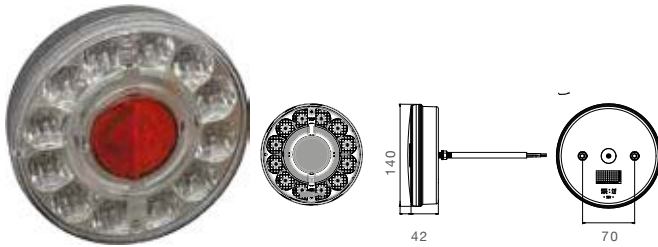

	Rückfahrlicht Reverse light		Rücklicht Tail light		Nebelschlusslicht Fog light
	Rückstrahler rot Reflector red				

BEST. NR PART NO		←	→				ZUSATZ	ANSCHLUSS		
							ADD ON	CONNECTOR		
33-8100-201	1/-	●	●	LED	12V 24V			offenes Ende open end	0,50 m	
33-8100-701	1/-	●	●	LED	12V 24V			8 pol. Bajonett 8 pin Bayonet	♂	0,50 m
33-8107-021	1/-	●	●	LED	12V 24V			7 pol. ASS2 7 pin ASS2	♂	0,50 m
33-8107-031	1/-	●	●	LED	12V 24V			7 pol. ASS2 7 pin ASS2	♂	0,50 m



BRASPOINT 140

ADR Zone 2 IP 6K9K

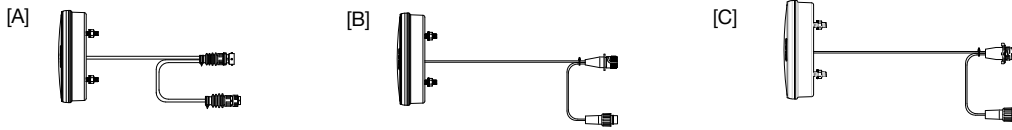
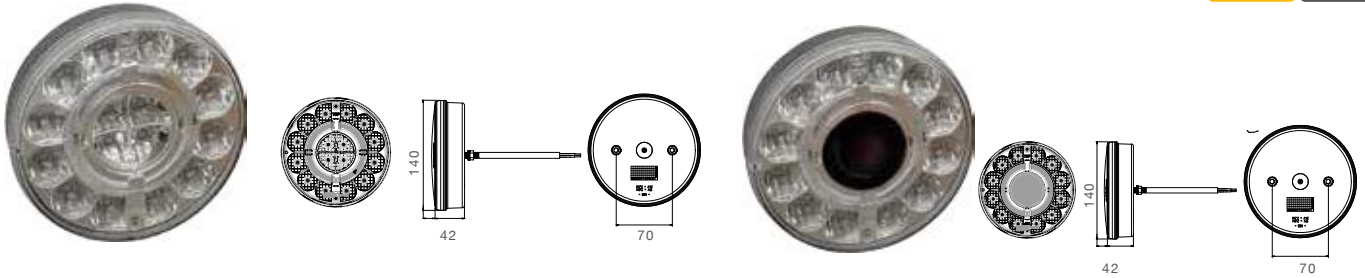

Blinklicht Direction indicator	Rücklicht Tail light	Bremslicht Stop light	
-----------------------------------	-------------------------	--------------------------	--

BEST. NR	PART NO		←	→				ZUSATZ ADD ON	ANSCHLUSS CONNECTOR	
33-9200-201	1/-		●	●	LED	12V 24V			offenes Ende open end	0,50 m
33-9200-701	1/-		●	●	LED	12V 24V			5 pol. Bajonett 5 pin Bayonet	0,50 m
33-9200-711	1/-		●	●	LED	12V 24V		[A]	8 pol. Bajonett 8 pin Bayonet	0,50 m
									8 pol. Bajonett 8 pin Bayonet	0,25 m
33-9207-061	1/-		●	●	LED	12V 24V		[B]	7 pol. ASS2 7 pin ASS2	0,50 m
									7 pol. ASS2 7 pin ASS2	0,20 m
33-9207-091	-/-		●	●	LED	12V 24V		[C]	7 pol. AMP 7 pin AMP	0,50 m
									7 pol. ASS2 7 pin ASS2	0,20 m
33-9200-301	-/-		●	●	LED	12V 24V			offenes Ende open end	0,50 m
33-9207-071	-/-		●	●	LED	12V 24V		[B]	7 pol. ASS2 7 pin ASS2	0,50 m
									7 pol. ASS2 7 pin ASS2	0,20 m



BRASPOINT 140

ZUBEHÖHR / ACCESSORIES

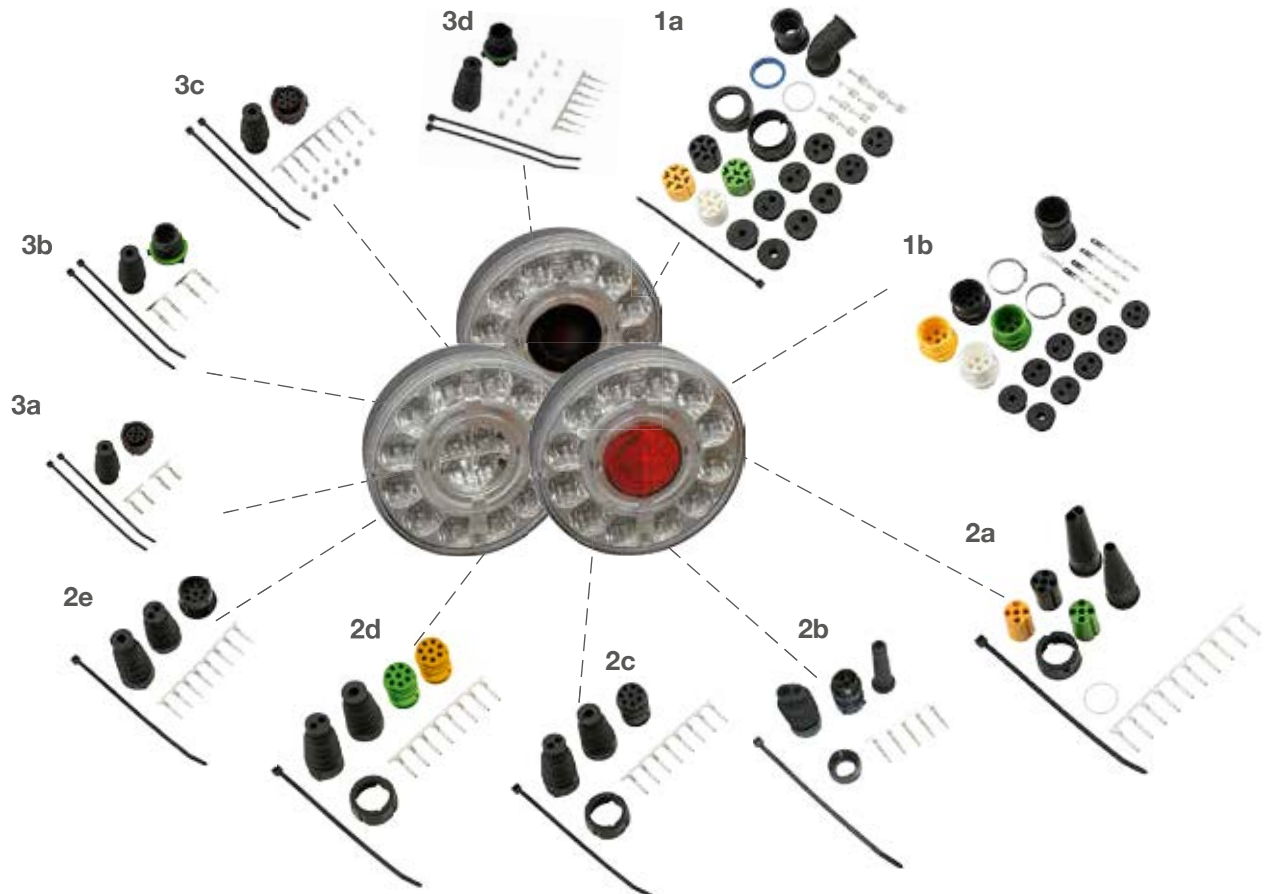

1 ASS1 & ASS2 Verbinder | ASS1 & ASS2 connector

- (a) 7 pol. weiblich
7 pin female 13-5626-631
- (b) 7 pol. männlich
7 pin male 13-5625-981

2 Bajonett Verbinder | bayonet connector

- (a) 5 pol. weiblich
5 pin female 13-0521-104
- (b) 5 pol. männlich
5 pin male 13-0536-044
- (c) 8 pol. weiblich
8 pin female 13-0828-034
- (d) 8 pol. weiblich
8 pin female 15-0821-524
- (e) 8 pol. männlich
8 pin male 13-0838-054

3 AMP Verbinder | AMP connector

- (a) 4 pol. weiblich
4 pin female 15-7002-004
- (b) 4 pol. männlich
4 pin male 15-7002-014
- (c) 7 pol. weiblich
7 pin female 15-7002-024
- (d) 7 pol. männlich
7 pin male 15-7002-034



ROUNDPOINT II

ADR Zone 2 IP6K9K

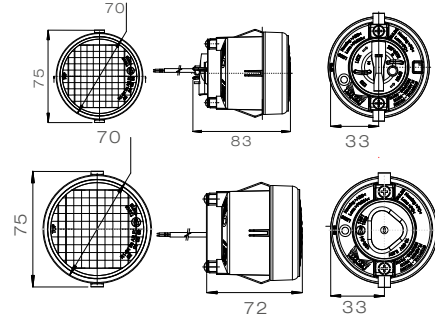

BEST. NR PART NO	☐	←	→	💡	⚡ V	🔵	ZUSATZ	ANSCHLUSS
							ADD ON	CONNECTOR
31-7600-001	1/-	●	●	💡	12V	🟡	↔	offenes Ende open end 1,80 m ⤴
32-7600-001	1/-	●	●	💡	12V	🔴	↔ (S)	offenes Ende open end 1,80 m ⤴
37-7600-001	1/-	●	●	💡	12V	🔴	⊕	offenes Ende open end 1,80 m ⤴
38-7600-001	1/-	●	●	💡	12V	⚪	⊖	offenes Ende open end 1,80 m ⤴

ROUNDPOINT II LED

ZUBEHÖHR / ACCESSORIES

ADR Zone 2 IP6K9K

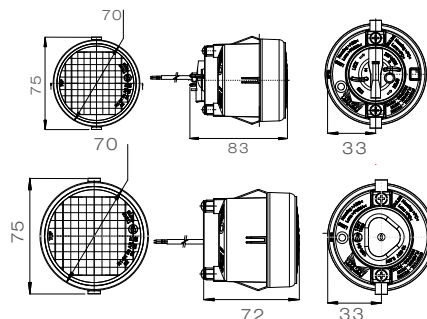

BEST. NR		←	→	💡	⚡	🔦	ZUSATZ	ANSCHLUSS
PART NO	📦			LED	12V 24V		ADD ON	CONNECTOR
31-7600-701	1/-	●	●	LED	12V 24V			offenes Ende open end 1,80 m
32-7600-701	1/-	●	●	LED	12V 24V			offenes Ende open end 1,80 m
37-7600-701	1/-	●	●	LED	12V 24V			offenes Ende open end 1,80 m
38-7600-701	1/-	●	●	LED	12V 24V			offenes Ende open end 1,80 m

ZUBEHÖHR / ACCESSORIES

1 Lichtscheibe inklusive Gehäuse | lens including housing

- (a) 21-7600-001
- (b) 22-7600-001
- (c) 27-7600-001
- (d) 28-7600-001

Glühlampe | bulb

- 12V 21W, BA15s 16-6121-017
- 12V 21W / 5W 16-6122-017





3 CHAMBER LAMP II LED

ADR
Zone 2

IP 54

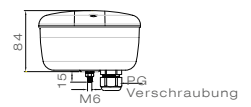
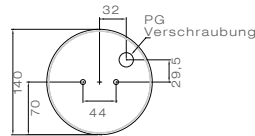
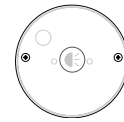
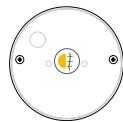
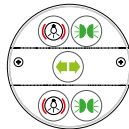
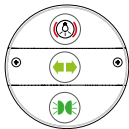

BEST. NR	PART NO	←	→	LED	V	ZUSATZ	ANSCHLUSS	
ADD ON							CONNECTOR	
22-7000-701	1/-	●	●	LED	12V 24V	☉ ☉	PG 11 Verschraubung cable glands 11	☉ ☉
23-8400-751	1/-	●	●	LED	12V 24V	☉ 2x ☉ 2x ☉	PG 16 Verschraubung cable glands 16	☉ ☉
23-8400-761	1/-	●	●	LED	12V 24V	☉ 2x ☉ 2x ☉	PG 16 Verschraubung cable glands 16	☉ ☉
23-8400-771	1/-	●	●	LED	12V 24V	☉ 2x ☉ 2x ☉	8 pol. Bajonett 8 pin Bayonet	♂ ☉ ☉
23-8400-781	1/-	●	●	LED	12V 24V	☉ 2x ☉ 2x ☉	5 pol. Bajonett 5 pin Bayonet	♂ ☉ ☉
23-8400-801	1/-	●	●	LED	12V 24V	☉ ☉ ☉	PG 11 Verschraubung cable glands 11	☉ ☉
23-8400-811	1/-	●	●	LED	12V 24V	☉ ☉ ☉	PG16 Verschraubung cable glands 16	☉ ☉
23-8400-821	1/-	●	●	LED	12V 24V	☉ ☉ ☉	8 pol. Bajonett 8 pin Bayonet	♂ ☉ ☉
27-8100-721	1/-	●	●	LED	12V 24V	☉	8 pol. Bajonett 8 pin Bayonet	♂ ☉ ☉
27-8400-701	1/-	●	●	LED	12V 24V	☉	PG 11 Verschraubung cable glands 11	☉ ☉
28-8100-731	1/-	●	●	LED	12V 24V	☉	8 pol. Bajonett 8 pin Bayonet	♂ ☉ ☉
28-8400-701	1/-	●	●	LED	12V 24V	☉	PG 11 Verschraubung cable glands 11	☉ ☉
32-7000-701	1/-	●	●	LED	12V 24V	☉ ☉	7 pol. ASS2 7 pin ASS2	♂ ☉ ☉ 1,50 m ☐
33-8400-011	1/-		●	LED	12V 24V	☉ ☉ ☉	offnes Ende open end	2,50 m ☐
33-8402-031	1/-		●	LED	12V 24V	☉ 2x ☉ 2x ☉	offnes Ende open end	0,50 m ☐
33-8403-031	1/-	●		LED	12V 24V	☉ 2x ☉ 2x ☉	offnes Ende open end	0,50 m ☐



3 CHAMBER LAMP II LED



IP 54

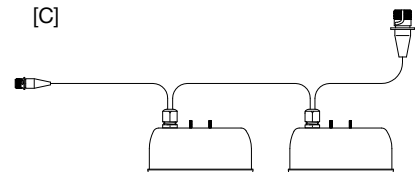
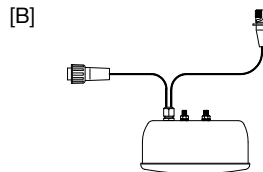
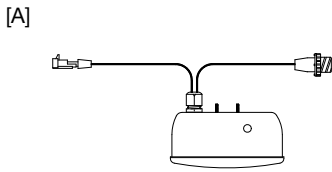

BEST. NR	PART NO	←	→	LED	12V 24V	Lamp Icon	ZUSATZ	ANSCHLUSS				
ADD ON							CONNECTOR	Length	Symbol			
33-8403-041	1/-	●		LED	12V 24V					offnes Ende open end	0,50 m	
33-8405-081	1/-	●		LED	12V 24V			2x	2x	7 pol. ASS2 7 pin ASS2	0,50 m	
33-8405-091	1/-	●		LED	12V 24V					7 pol. ASS2 7 pin ASS2	0,50 m	
33-8405-101	1/-	●		LED	12V 24V					7 pol. AMP 7 pin AMP	0,90 m	
										2 pol. Superseal 2 pin Superseal	1,00 m	
33-8406-081	1/-		●	LED	12V 24V			2x	2x	7 pol. ASS2 7 pin ASS2	0,50 m	
33-8406-091	1/-		●	LED	12V 24V					7 pol. ASS2 7 pin ASS2	0,50 m	
33-8406-101	1/-		●	LED	12V 24V		[A]			7 pol. AMP 7 pin AMP	0,90 m	
										2 pol. Superseal 2 pin Superseal	1,00 m	
33-8407-014	1/-	●	●	LED	12V 24V		[B]			7 pol. ASS2 7 pin ASS2	0,15 m	
										7 pol. ASS2 7 pin ASS2	0,15 m	
37-8400-001	1/-	●	●	LED	12V 24V					2 pol. Superseal 2 pin Superseal	0,55 m	
37-8407-001	1/-	●	●	LED	12V 24V					2 pol. ASS2 2 pin ASS2	1,50 m	
38-8107-061	1/-	●	●	LED	12V 24V					7 pol. ASS2 7 pin ASS2	0,15 m	
38-8407-001	1/-	●	●	LED	12V 24V					2 pol. ASS2 2 pin ASS2	1,50 m	
39-7000-001	1/-	●	●	LED	12V 24V					3 pol. AMP 3 pin AMP	0,58 m	
39-7007-001	1/-	●	●	LED	12V 24V					7 pol. ASS2 7 pin ASS2	0,15 m	
87-3079-001	1/-	●		LED	12V 24V		[C]			7 pol. AMP 7 pin AMP	0,90 m	
										2 pol. Superseal 2 pin Superseal	1,00 m	
87-3080-001	1/-		●	LED	12V 24V		[C]			7 pol. AMP 7 pin AMP	0,90 m	
										2 pol. Superseal 2 pin Superseal	1,00 m	



3 CHAMBER LAMP II LED

ZUBEHÖHR / ACCESSORIES

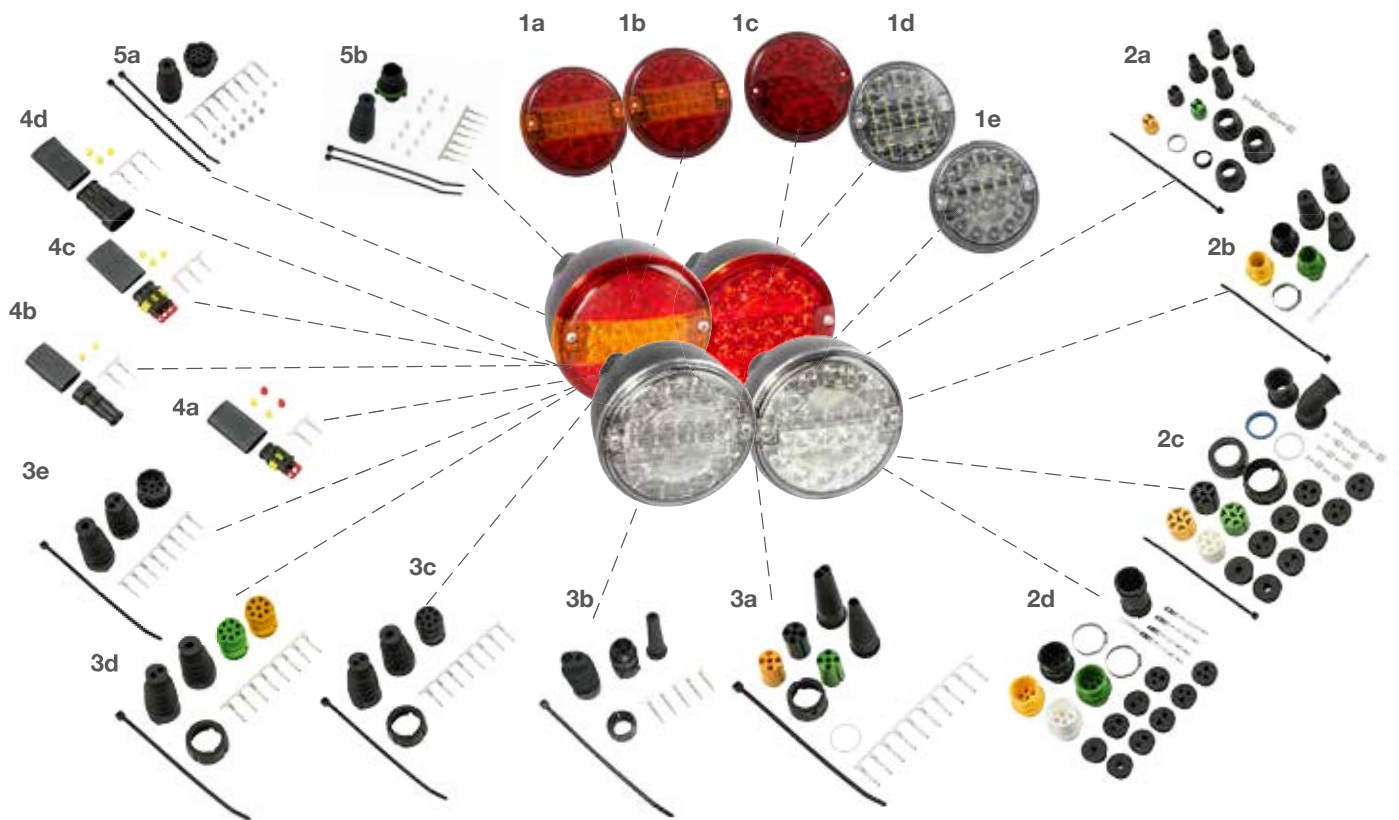

- 1 Lichtscheibe | lens**
- (a) 3 Kammerleuchte Doppelfunktion
3 Chamber double function
..... 18-8384-501
 - (b) 3 Kammerleuchte Einfunktion
3 chamber single function
..... 18-8384-551
 - (c) mit
with 18-8784-501
 - (d) mit
with 18-8884-501
 - (e) mit
with 22-7000-001

- 2 ASS1 & ASS2 Verbinder | ASS1 & ASS2 connector**
- (a) 2 pol. weiblich
2 pin female 13-5626-401
 - (b) 2 pol. männlich
2 pin male 13-5625-991
 - (c) 7 pol. weiblich
7 pin female 13-5626-631
 - (d) 7 pol. männlich
7 pin male 13-5625-981

- 3 Bajonett Verbinder | bayonet connector**
- (a) 5 pol. weiblich
5 pin female 13-0521-104

- (b) 5 pol. männlich
5 pin male 13-0536-044
- (c) 8 pol. weiblich
8 pin female 13-0828-034
- (d) 8 pol. weiblich
8 pin female 15-0821-524
- (e) 8 pol. männlich
8 pin male 13-0838-054

- 4 Superseal Verbinder | Superseal connector**
- (a) 2 pol. weiblich
2 pin female 15-7002-044
 - (b) 2 pol. männlich
2 pin male 15-7002-054
 - (c) 3 pol. weiblich
3 pin female 15-7002-064
 - (d) 3 pol. männlich
3 pin male 15-7002-074

- 5 AMP Verbinder | AMP connector**
- (a) 7 pol. weiblich
7 pin female 15-7002-024
 - (b) 7 pol. männlich
7 pin male 15-7002-034



3 CHAMBER LAMP I LED

ADR
Zone 2

IP 54

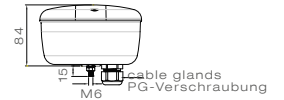
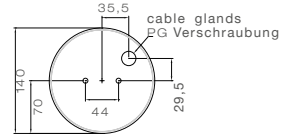
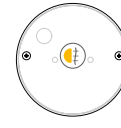
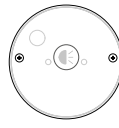
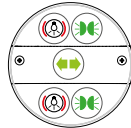
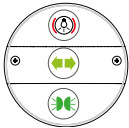

BEST. NR		←	→	💡	⚡		ZUSATZ	ANSCHLUSS
PART NO							ADD ON	CONNECTOR
23-8400-701	1/-	●	●	LED	24V			8 pol. Bajonett 8 pin Bayonet ♂
23-8400-711	1/-	●	●	LED	24V			PG 16 Verschraubung cable glands 16
23-8400-721	1/-	●	●	LED	24V			PG 11 Verschraubung cable glands 11
23-8500-701	1/-	●	●	LED	24V		2x 2x	8 pol. Bajonett 8 pin Bayonet ♂
23-8500-711	1/-	●	●	LED	24V		2x 2x	PG 16 Verschraubung cable glands 16
23-8500-721	1/-	●	●	LED	24V		2x 2x	PG 11 Verschraubung cable glands 11
27-8100-701	1/-	●	●	LED	24V			PG 9 Verschraubung cable glands 9
28-8100-711	1/-	●	●	LED	24V			PG 9 Verschraubung cable glands 9

ZUBEHÖHR / ACCESSORIES

- 1** Bajonett Verbinder | bayonet connector
8 pol. weiblich
8 pin female 13-0828-034





3 CHAMBER LAMP

ADR Zone 2

IP 54

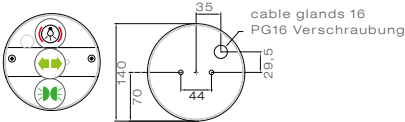
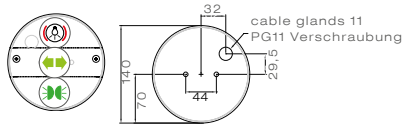
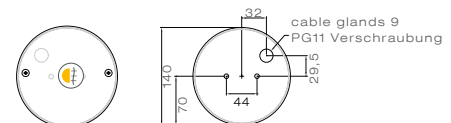
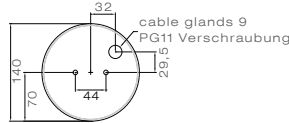
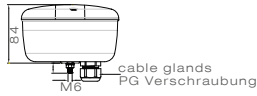

BEST. NR	PART NO	←	→	💡	⚡	ZUSATZ	ANSCHLUSS
						ADD ON	CONNECTOR
23-8200-011	1/-	●	●	💡	24V		PG 11 Verschraubung cable glands 11
23-8200-511	1/-	●	●	💡	24V		8 pol. Bajonett 8 pin Bayonet
23-8220-001	1/-	●	●	💡	24V		18,5 mm Loch 18,5 mm hole
23-8230-001	1/-	●	●	💡	24V		PG 16 Verschraubung cable glands 16
27-8000-021	1/-	●	●	💡	24V		PG 9 Verschraubung cable glands 9
27-8001-511	1/-	●	●	💡	24V		8 pol. Bajonett 8 pin Bayonet
28-8000-021	1/-	●	●	💡	24V		PG 9 Verschraubung cable glands 9
28-8001-521	1/-	●	●	💡	24V		8 pol. Bajonett 8 pin Bayonet
33-8205-031	-/-	●		💡	24V	[A]	7 pol. ASS2 7 pin ASS2 0,50 m
33-8205-081	1/-	●		💡	24V		7 pol. ASS2 7 pin ASS2 1,50 m
33-8205-101	1/-	●		💡	24V	[B]	7 pol. AMP 7 pin AMP 0,90 m
							2 pol. Superseal 2 pin Superseal 1,00 m
33-8206-031	-/-		●	💡	24V	[A]	7 pol. ASS2 7 pin ASS2 0,50 m
33-8206-091	1/-		●	💡	24V		7 pol. ASS2 7 pin ASS2 1,50 m
33-8206-101	1/-		●	💡	24V	[B]	7 pol. AMP 7 pin AMP 0,90 m
							2 pol. Superseal 2 pin Superseal 1,00 m



3 CHAMBER LAMP

ADR
Zone 2

IP 54

[A]

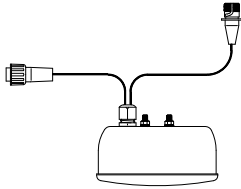

[B]

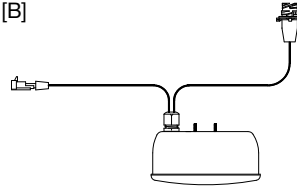

BEST. NR PART NO		←	→				ZUSATZ	ANSCHLUSS
							ADD ON	CONNECTOR
37-8000-041	-/-	●	●		24V			2 pol. Superseal 2 pin Superseal ♀ 0,25 m
37-8000-061	-/-	●	●		24V			2 pol. Superseal 2 pin Superseal ♀ 1,60 m
37-8007-131	1/-	●	●		24V			2 pol. ASS2 2 pin ASS2 ♀ 0,25 m
37-8007-161	-/-	●	●		24V			2 pol. ASS2 2 pin ASS2 ♀ 1,20 m
37-8007-191	1/-	●	●		24V			2 pol. ASS2 2 pin ASS2 ♀ 3,00 m
38-8000-031	-/-	●	●		24V			2 pol. Superseal 2 pin Superseal ♂ 0,25 m
38-8000-051	-/-	●	●		24V			2 pol. Superseal 2 pin Superseal ♀ 0,25 m
38-8000-061	-/-	●	●		24V			2 pol. Superseal 2 pin Superseal ♀ 1,60 m
38-8007-131	1/-	●	●		24V			2 pol. ASS2 2 pin ASS2 ♀ 0,25 m
38-8007-141	-/-	●	●		24V			2 pol. ASS2 2 pin ASS2 ♀ 3,00 m
38-8007-151	-/-	●	●		24V			2 pol. ASS2 2 pin ASS2 ♀ 1,20 m



3 CHAMBER LAMP

ADR
Zone 2

IP 54

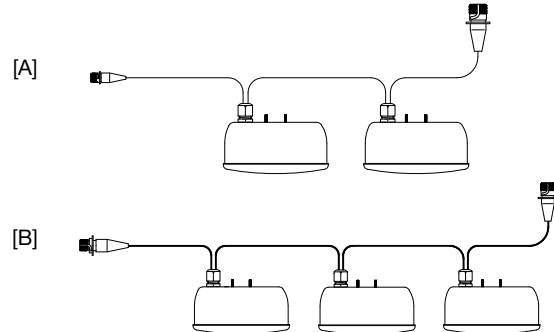
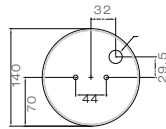
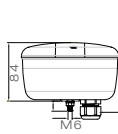

Blinklicht Direction indicator	Rücklicht Tail light	Bremslicht Stop light	

BEST. NR PART NO		←	→				ZUSATZ	ANSCHLUSS	
							ADD ON	CONNECTOR	
87-3047-021	1/-		●		24V		[A]	7 pol. ASS2 7 pin ASS2 2 pol. ASS2 2 pin ASS2	 0,90 m 1,00 m
87-3048-021	1/-	●			24V		[A]	7 pol. ASS2 7 pin ASS2 2 pol. ASS2 2 pin ASS2	 0,90 m 1,00 m
87-3067-001	-/-		●		24V		[B]	7 pol. ASS2 7 pin ASS2 2 pol. ASS2 2 pin ASS2	 0,90 m 1,00 m
87-3068-001	-/-	●			24V		[B]	7 pol. ASS2 7 pin ASS2 2 pol. ASS2 2 pin ASS2	 0,90 m 1,00 m
87-3081-001	1/-	●			24V		[B]	7 pol. AMP 7 pin AMP 2 pol. Superseal 2 pin Superseal	 0,90 m 1,00 m
87-3082-001	1/-		●		24V		[B]	7 pol. AMP 7 pin AMP 2 pol. Superseal 2 pin Superseal	 0,90 m 1,00 m



3 CHAMBER LAMP

ZUBEHÖHR / ACCESSORIES

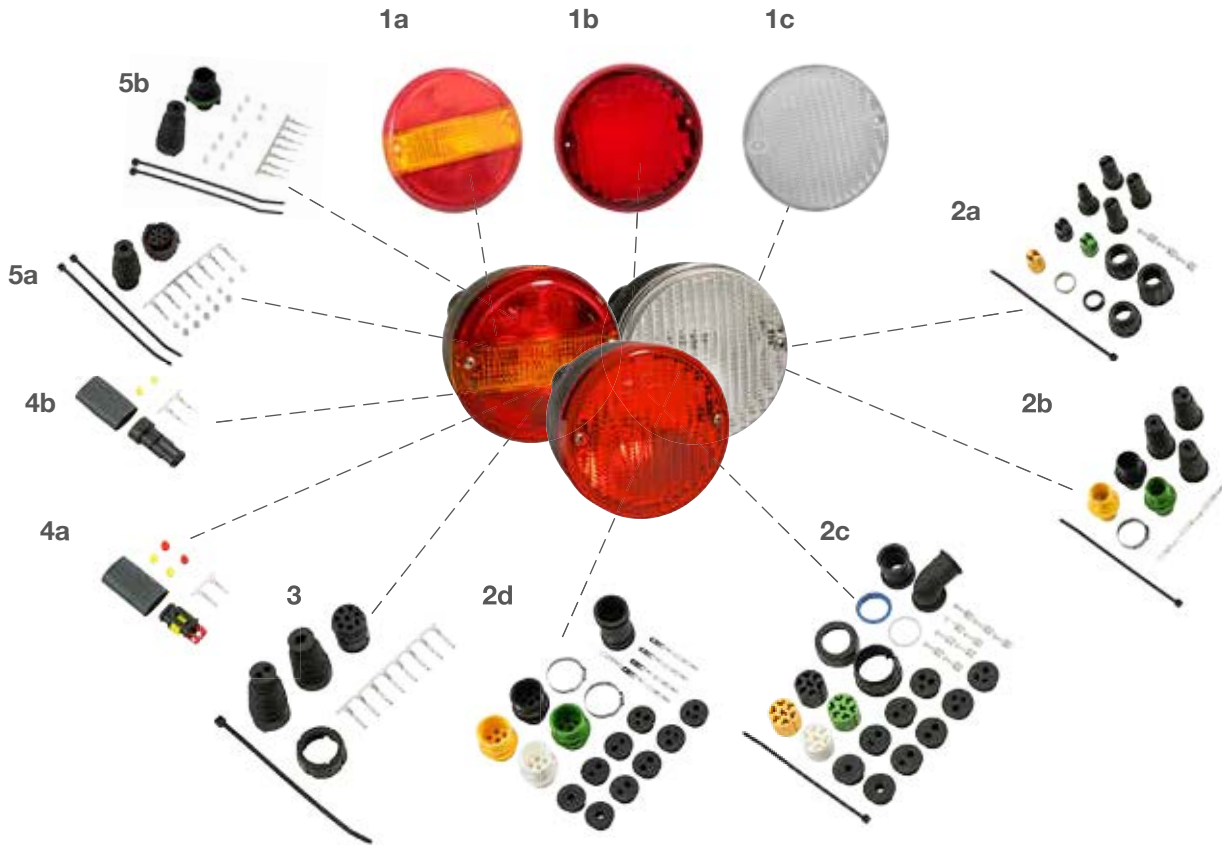

1 Lichtscheibe | lens

- (a) 3 Kammerleuchte
3 chamber lamp..... 18-8382-104
- (b) mit
with 18-8780-104
- (c) mit
with 18-8880-104

2 ASS1 & ASS2 Verbinder | ASS1 & ASS2 connector

- (a) 2 pol. weiblich
2 pin female 13-5626-401
- (b) 2 pol. männlich
2 pin male 13-5625-991
- (c) 7 pol. weiblich
7 pin female 13-5626-631
- (d) 7 pol. männlich
7 pin male 13-5625-981

3 Bajonett Verbinder | bayonet connector

- 8 pol. weiblich
8 pin female 13-0828-034

4 Superseal Verbinder | Superseal connector

- (a) 2 pol. weiblich
2 pin female 15-7002-044
- (b) 2 pol. männlich
2 pin male 15-7002-054

5 AMP Verbinder | AMP connector

- (a) 7 pol. weiblich
7 pin female 15-7002-024
- (b) 7 pol. männlich
7 pin male 15-7002-034

Glühlampe | bulb

- 24V 21W 16-6321-027
- 24V 10W 16-6321-037

FASTBOOK[®]

SYSTEMS



UMRISSLEUCHE

Um eine flexible und optimale Anbringung zu ermöglichen, werden Aspöck Umrissleuchten mit verschiedenen Befestigungswinkeln angeboten. Somit kann die Begrenzung des Fahrzeuges sichtbar gemacht und mehr Sicherheit garantiert werden.

END OUTLINE MARKER

In order to permit flexible and optimum attachment, Aspöck end-outline marker lamps are offered with various mounting brackets. In this way, accurate delimitation of the vehicle can be achieved and therefore a higher level of safety guaranteed.

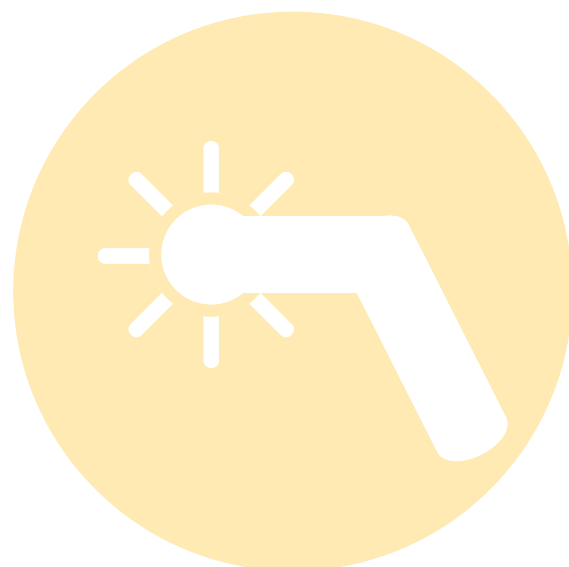



FLEXIPOINT I



[A]

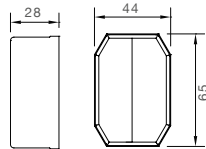

[B]

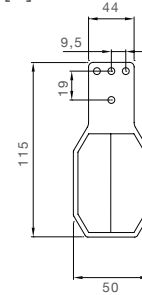

Umrissleuchte
End outline marker

BEST. NR		←	→	💡	⚡	ZUSATZ				ANSCHLUSS			
PART NO						ADD ON				CONNECTOR			
31-6504-084	1/-	●	●	💡	24V	[A]				P&R		0,50 m	
31-6504-134	-/-	●	●	💡	24V	[A]				P&R		2,00 m	
31-6504-104	-/-	●	●	💡	24V	[A]				P&R		0,50 m	
31-6504-174	1/-	●	●	💡	24V	[A]				P&R		0,50 m	
31-6564-064	1/-		●	💡	24V	[B]				P&R		0,50 m	
31-6564-074	-/-	●		💡	24V	[B]				P&R		0,50 m	
31-6564-144	1/-		●	💡	24V	[B]				P&R		1,50 m	
31-6564-154	1/-	●		💡	24V	[B]				P&R		1,50 m	



FLEXIPOINT I

ZUBEHÖHR / ACCESSORIES

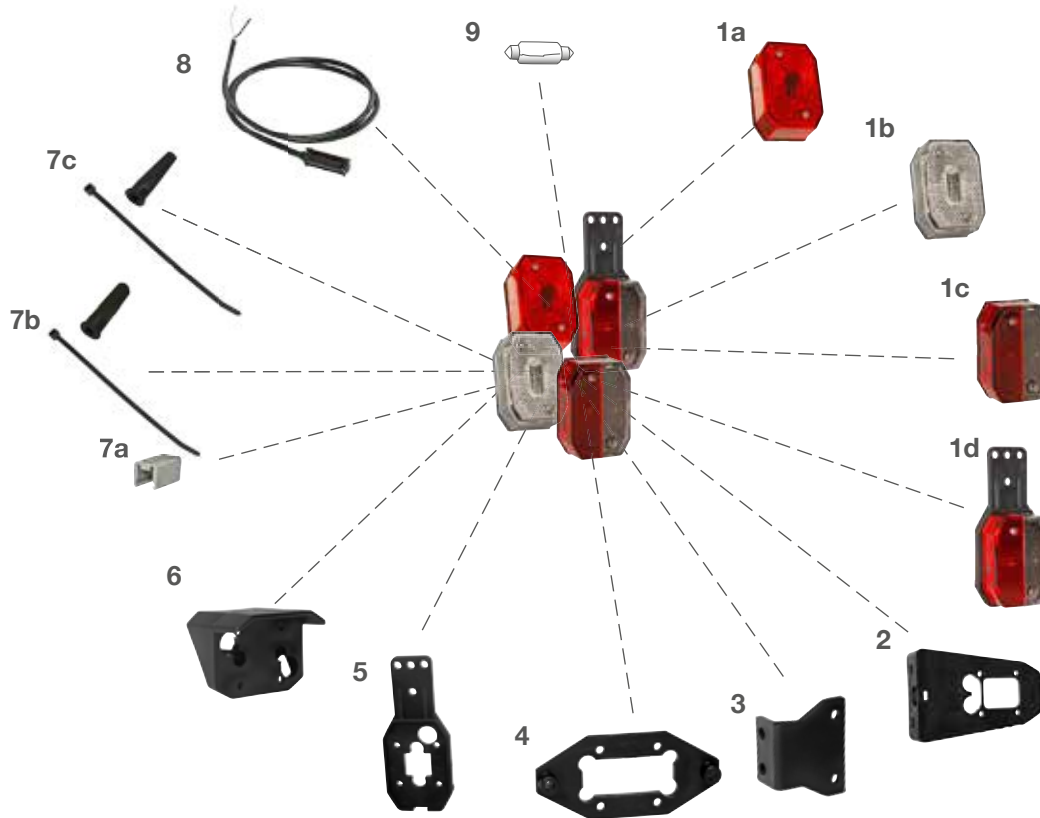

1 Ersatzteileuchte I spare part lamp

- (a) rot 21-6510-004
- (b) weiß 21-6512-004
- (c) rot/weiß 21-6513-004
- (d) rot/weiß mit Aufhängelasche
red/white with bracket 21-6513-214

2 Aufhängelasche I bracket

..... 15-5310-104

3 90° Halter I 90° bracket

..... 15-5318-104

4 wendbare Halteplatte I turnable flat bracket

..... 15-5316-004

5 flexibler gerader Gummihalter I flexible straight rubber bracket

..... 15-5312-104

6 schräger Haltewinkel I sloping bracket

..... 15-5314-104

7 für P&R Verbinder I for P&R connector

- (a) Verschlusskappen
caps 15-5971-014
- (b) Endkappen rund
end caps round 15-5983-024
- (c) Endkappen eckig
end caps square 15-5729-014

8 Zuleitung P&R I front connection P&R

- 0,5 m 68-5000-574
- 1,5 m 68-5000-604
- 5,0 m 68-5000-634

9 Soffitte

24V 5W 16-6705-017





SUPERPOINT IV LED

ADR Zone 2 IP69K

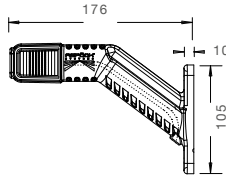

Umrissleuchte
End outline marker

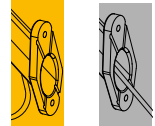

BEST. NR						ZUSATZ	ANSCHLUSS	
PART NO						ADD ON	CONNECTOR	
31-3104-004	1/-	●		LED	12V 24V		P&R	2,00 m
31-3105-004	1/-	●		LED	12V 24V		2 pol. ASS2 2 pin ASS2	♀ 2,00 m
31-3103-034	1/-	●		LED	12V 24V		2 pol. Superseal 2 pin Superseal	♀ 1,00 m
31-3104-014	1/-		●	LED	12V 24V		P&R	2,00 m
31-3106-004	1/-		●	LED	12V 24V		2 pol. ASS2 2 pin ASS2	♀ 2,00 m
31-3102-034	1/-		●	LED	12V 24V		2 pol. Superseal 2 pin Superseal	♀ 1,00 m
31-3103-024	1/-	●		LED	12V 24V		offenes Ende open end	0,25 m
31-3102-024	1/-		●	LED	24V		offenes Ende open end	0,25 m
31-3100-004	2/-	●		LED	24V		P&R	2,00 m
			●				P&R	2,00 m



SUPERPOINT IV LED

ZUBEHÖHR / ACCESSORIES

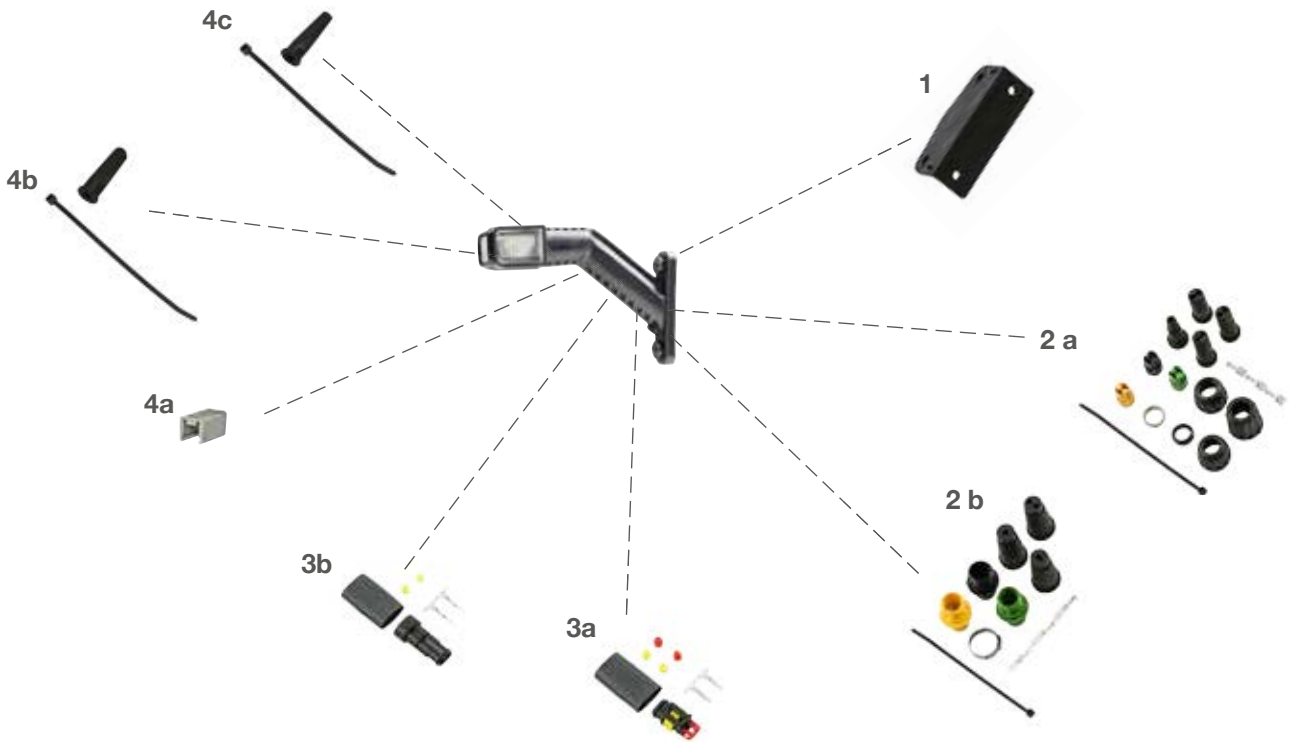

1 Befestigungswinkel für Leuchtarm |
angle bracket for end outline marker
..... 15-5313-004

2 ASS1 & ASS2 Verbinder |
ASS1 & ASS2 connector
(a) 2 pol. weiblich
2 pin female 13-5626-401
(b) 2 pol. männlich
2 pin male 13-5625-991

3 Superseal Verbinder | Superseal connector
(a) 2 pol. weiblich
2 pin female 15-7002-044
(b) 2 pol. männlich
2 pin male 15-7002-054

4 für P&R Verbinder |
for P&R connector
(a) Verschlusskappen
caps 15-5971-014
(b) Endkappen rund
end caps round 15-5983-024
(c) Endkappen eckig
end caps square 15-5729-014



SUPERPOINT III LED

ADR Zone 2 IP69K

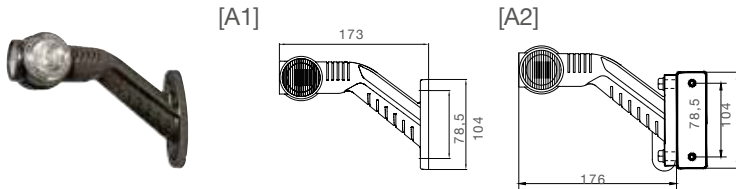

Umrissleuchte
End Outline Marker

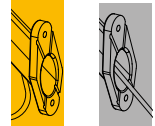
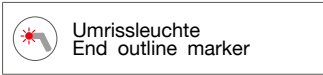

BEST. NR						ZUSATZ			ANSCHLUSS						
PART NO						ADD ON			CONNECTOR						
31-3365-094	1/-	●		LED	24V	[A2]				2 pol. ASS2 2 pin ASS2	♀			1,50 m	
31-3366-094	1/-		●	LED	24V	[A2]				2 pol. ASS2 2 pin ASS2	♀			1,50 m	
31-3300-074	1/-	●		LED	24V	[A1]				offenes Ende open end				4,00 m	
31-3302-054	1/-	●		LED	24V	[A1]				2 pol. Superseal 2 pin Superseal	♀			0,50 m	
31-3303-054	1/-		●	LED	24V	[A1]				2 pol. Superseal 2 pin Superseal	♀			0,50 m	
31-3304-044	1/-	●		LED	24V	[A1]				P&R				1,25 m	
31-3304-054	1/-		●	LED	24V	[A1]				P&R				1,25 m	
31-3304-114	1/-		●	LED	24V	[A1]				P&R				1,25 m	
31-3304-124	1/-	●		LED	24V	[A1]				P&R				1,25 m	
31-3304-134	1/-		●	LED	24V	[A1]				P&R				1,75 m	
31-3304-144	1/-	●		LED	24V	[A1]				P&R				1,75 m	
31-3305-014	1/-	●		LED	24V	[A1]				2 pol. ASS2 2 pin ASS2	♀			1,75 m	
31-3305-044	1/-	●		LED	24V	[A1]				2 pol. ASS2 2 pin ASS2	♀			2,00 m	
31-3305-124	1/-	●		LED	24V	[A1]				3 pol. ASS3 3 pin ASS3	♀			1,25 m	
31-3305-214	1/-	●		LED	24V	[A1]				2 pol. ASS2 2 pin ASS2	♀			0,50 m	
31-3305-294	1/-	●		LED	24V	[A1]				2 pol. Superseal 2 pin Superseal	♂			0,50 m	
31-3306-014	1/-		●	LED	24V	[A1]				2 pol. ASS2 2 pin ASS2	♀			1,50 m	









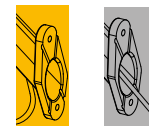































































































SUPERPOINT III LED

ADR Zone 2  IP69K



 Umrissleuchte
End outline marker



BEST. NR						ZUSATZ				ANSCHLUSS					
PART NO						ADD ON				CONNECTOR					
31-3306-044	1/-		●	LED	24V	[A1]				2 pol. ASS2 2 pin ASS2	♀			2,00 m	
31-3306-124	1/-		●	LED	24V	[A1]				3 pol. ASS3 3 pin ASS3	♀			1,25 m	
31-3306-214	1/-		●	LED	24V	[A1]				2 pol. ASS2 2 pin ASS2	♀			0,50 m	
31-3306-294	1/-		●	LED	24V	[A1]				2 pol. Superseal 2 pin Superseal	♂			0,50 m	
31-3362-004	1/-		●	LED	24V	[B]				2 pol. Superseal 2 pin Superseal	♀			0,25 m	
31-3362-104	1/-		●	LED	24V	[B]				2 pol. Superseal 2 pin Superseal	♂			1,50 m	
31-3363-004	1/-	●		LED	24V	[B]				2 pol. Superseal 2 pin Superseal	♀			0,25 m	
31-3363-104	1/-	●		LED	24V	[B]				2 pol. Superseal 2 pin Superseal	♂			1,50 m	
31-3364-024	1/-		●	LED	24V	[B]				P&R				1,50 m	
31-3364-054	1/-	●		LED	24V	[B]				P&R				1,50 m	
31-3365-014	1/-	●		LED	24V	[B]				offenes Ende open end				4,00 m	
31-3365-054	1/-	●		LED	24V	[B]				2 pol. ASS2 2 pin ASS2	♀			0,25 m	
31-3365-064	1/-	●		LED	24V	[B]				3 pol. ASS3 3 pin ASS3	♀			1,50 m	
31-3366-024	1/-		●	LED	24V	[B]				offenes Ende open end				4,00 m	
31-3366-054	1/-		●	LED	24V	[B]				2 pol. ASS2 2 pin ASS2	♀			0,25 m	
31-3366-064	1/-		●	LED	24V	[B]				3 pol. ASS3 3 pin ASS3	♀			1,50 m	
31-3305-084	1/-	●		LED	24V	[C]				offenes Ende open end				0,04 m	
31-3306-084	1/-		●	LED	24V	[C]				offenes Ende open end				0,04 m	



SUPERPOINT III LED

ADR Zone 2 IP69K

[D]

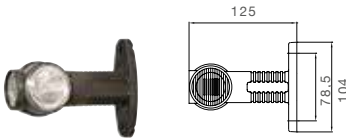

[E]

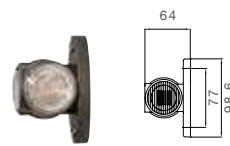

Umrissleuchte
End outline marker

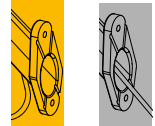

BEST. NR						ZUSATZ				ANSCHLUSS	
PART NO						ADD ON				CONNECTOR	
31-3300-244	1/-	●	●	LED	24V	[D]				offenes Ende open end	4,00 m
31-3302-064	1/-		●	LED	24V	[D]				2 pol. Superseal 2 pin Superseal	♀ 0,50 m
31-3303-064	1/-	●		LED	24V	[D]				2 pol. Superseal 2 pin Superseal	♀ 0,50 m
31-3304-094	1/-	●	●	LED	24V	[D]				P&R	1,25 m
31-3305-194	1/-	●		LED	24V	[D]				2 pol. ASS2 2 pin ASS2	♀ 2,00 m
31-3306-194	1/-		●	LED	24V	[D]				2 pol. ASS2 2 pin ASS2	♀ 2,00 m
31-3307-014	1/-	●	●	LED	24V	[D]				2 pol. ASS2 2 pin ASS2	♀ 1,75 m
31-3307-024	1/-	●	●	LED	24V	[D]				3 pol. ASS3 3 pin ASS3	♀ 1,75 m
31-3307-104	1/-	●	●	LED	24V	[D]				2 pol. ASS2 2 pin ASS2	♀ 2,50 m
31-3307-194	1/-	●	●	LED	24V	[D]				2 pol. Superseal 2 pin Superseal	♂ 2,00 m
31-3300-374	1/-	●	●	LED	24V	[E]				2 pol. Superseal 2 pin Superseal	♀ 3,00 m
31-3307-044	1/-	●	●	LED	24V	[E]				2 pol. ASS2 2 pin ASS2	♀ 1,50 m
31-3307-134	1/-	●	●	LED	24V	[E]				2 pol. ASS2 2 pin ASS2	♀ 3,00 m
31-3307-224	1/-	●	●	LED	24V	[E]				3 pol. ASS3 3 pin ASS3	♀ 0,50 m
31-3360-004	1/-	●	●	LED	24V	[E]				offenes Ende open end	4,00 m
31-3364-004	1/-	●	●	LED	24V	[E]				P&R	1,50 m
31-3367-004	1/-	●	●	LED	24V	[E]				2 pol. ASS2 2 pin ASS2	♀ 0,50 m

SUPERPOINT III LED

ZUBEHÖHR / ACCESSORIES

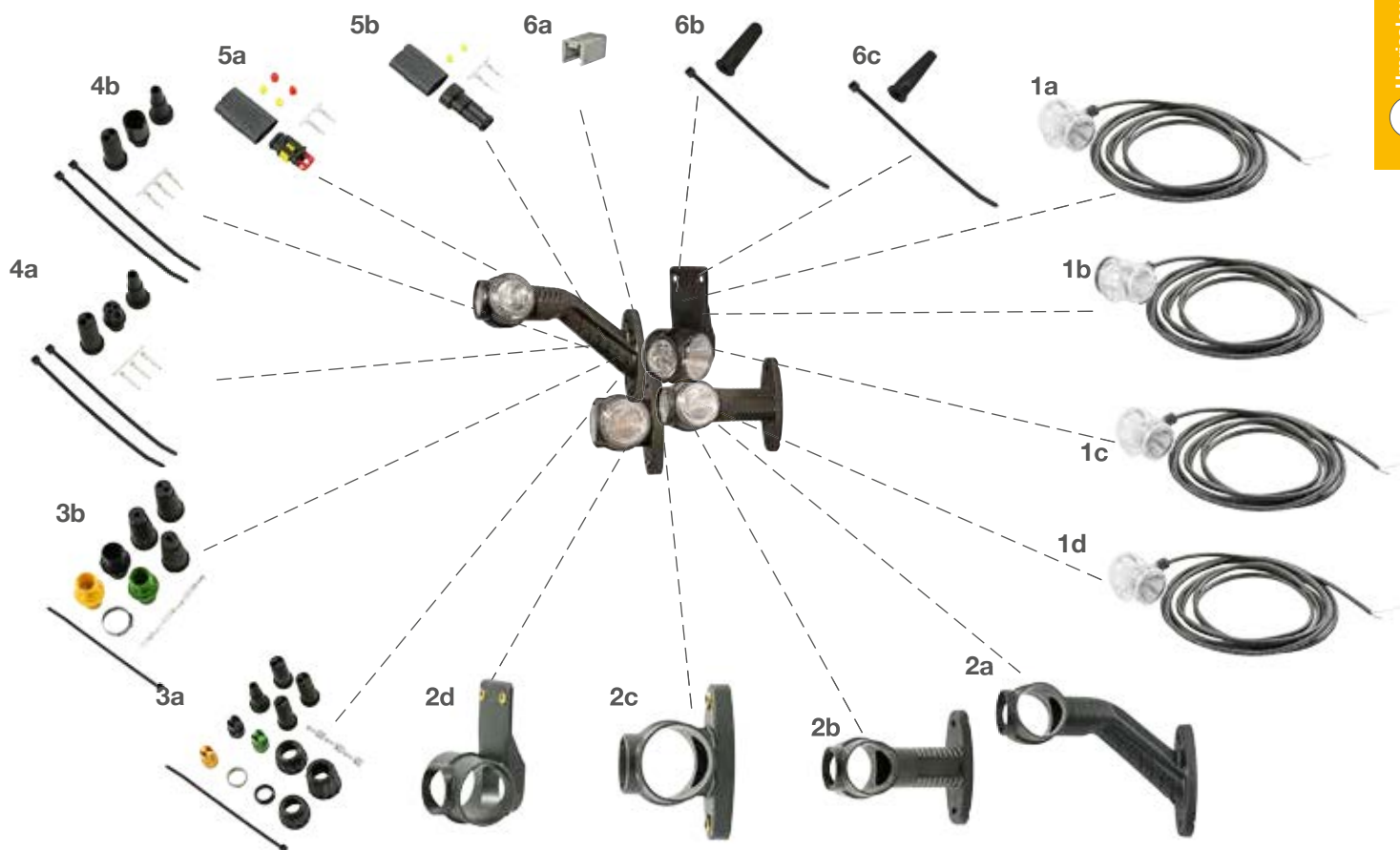

- 1 Lichtscheibe | lens**
- (a) rot/weiß/orange mit 4,00 m Kabel
red/white/orange with 4,00 m cable 21-3351-704
 - (b) schwarz/weiß/orange mit 4,00 m Kabel
black/white/orange with 4,00 m cable 21-3350-704
 - (c) rot/weiß/orange mit 1,50 m Kabel
red/white/orange with 1,50 m cable 21-3353-704
 - (d) rot/weiß/orange mit 3,00 m Kabel
red/white/orange with 3,00 m cable 21-3354-707

- 2 Umrißarm | end outline marker**
- (a) Standard
Standard..... 21-3300-007
 - (b) gerade
straight 21-3302-007
 - (c) Direktanbau
direct mounting 15-5325-004
 - (d) mit Pendelhalter
with pendular bracket.. 15-5325-101

- 3 ASS1 & ASS2 Verbinder | ASS1 & ASS2 connector**
- (a) 2 pol. weiblich
2 pin female 13-5626-401
 - (b) 2 pol. männlich
2 pin male 13-5625-991

- 4 ASS3 Verbinder | ASS3 connector**
- (a) 3 pol. weiblich
3 pin female 13-0322-281
 - (b) 3 pol. männlich
3 pin male 13-0332-281

- 5 Superseal Verbinder | Superseal connector**
- (a) 2 pol. weiblich
2 pin female 15-7002-044
 - (b) 2 pol. männlich
2 pin male 15-7002-054

- 6 für P&R Verbinder | for P&R connector**
- (a) Verschlusskappen
caps..... 15-5971-014
 - (b) Endkappen rund
end caps round..... 15-5983-024
 - (c) Endkappen eckig
end caps square..... 15-5729-014



SUPERPOINT II

ADR
Zone 2

IP 68

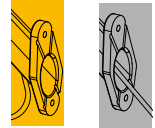
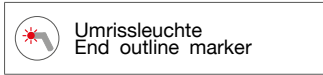
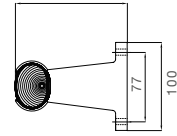
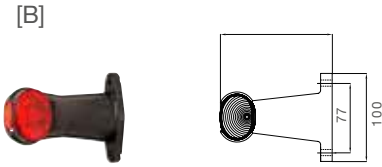
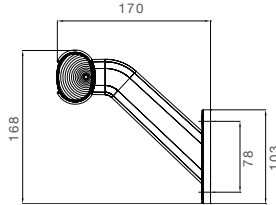

BEST. NR	PART NO						ZUSATZ	ANSCHLUSS
							ADD ON	CONNECTOR
31-3404-014	1/-	●			24V	[A1]		P&R 1,25 m
31-3404-104	-/-	●			24V	[A1]		P&R 1,80 m
31-3404-124	1/-	●			24V	[A1]		P&R 1,25 m
31-3404-364	-/-	●			24V	[A2]		P&R 1,80 m
31-3405-004	1/-	●			24V	[A1]		2 pol. ASS2 2 pin ASS2 ♀ 1,75 m
31-3405-074	-/-	●			24V	[A1]		3 pol. ASS3 3 pin ASS3 ♀ 1,25 m
31-3407-114	1/-	●			24V	[A1]		2 pol. ASS2 2 pin ASS2 ♀ 0,50 m
31-3404-004	1/-		●		24V	[A1]		P&R 1,25 m
31-3404-064	1/-		●		24V	[A1]		P&R 1,80 m
31-3404-114	-/-		●		24V	[A1]		P&R 1,80 m
31-3404-134	1/-		●		24V	[A1]		P&R 1,30 m
31-3406-004	1/-		●		24V	[A1]		2 pol. ASS2 2 pin ASS2 ♀ 1,75 m
31-3406-064	-/-		●		24V	[A1]		3 pol. ASS3 3 pin ASS3 ♀ 1,25 m
31-3407-104	1/-		●		24V	[A1]		2 pol. ASS2 2 pin ASS2 ♀ 0,50 m
31-3704-004	1/-	●	●		24V	[B]		P&R 0,50 m
31-3704-014	1/-	●	●		24V	[B]		P&R 1,50 m
31-3707-024	1/-	●	●		24V	[B]		2 pol. ASS2 2 pin ASS2 ♀ 1,75 m
31-3707-105	1/-	●			24V	[B]		2 pol. ASS2 2 pin ASS2 ♀ 2,00 m

SUPERPOINT II

ADR Zone 2

IP 68

[C]

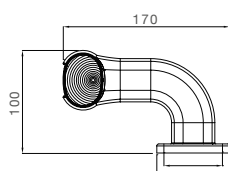

[D]

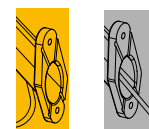
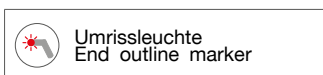
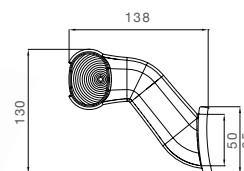

BEST. NR						ZUSATZ			ANSCHLUSS					
PART NO		←	→			ADD ON			CONNECTOR					
31-3707-144	1/-	●		💡	24V	[B]			2 pol. ASS2	♀			0,50 m	
31-3793-004	-/-	●		💡	24V	[B]			2 pol. Superseal	♀			0,50 m	
31-3707-095	-/-		●	💡	24V	[B]			2 pol. ASS2	♀			2,00 m	
31-3707-134	1/-		●	💡	24V	[B]			2 pol. ASS2	♀			0,50 m	
31-3792-004	-/-		●	💡	24V	[B]			2 pol. Superseal	♀			0,50 m	
31-3804-014	1/-	●		💡	24V	[C]			P&R				1,40 m	
31-3805-004	1/-	●		💡	24V	[C]			2 pol. ASS2	♀			0,75 m	
31-3805-024	-/-	●		💡	24V	[C]			2 pol. ASS3	♀			1,75 m	
31-3804-004	1/-		●	💡	24V	[C]			P&R				1,50 m	
31-3806-004	1/-		●	💡	24V	[C]			2 pol. ASS2	♀			1,75 m	
31-3806-024	-/-		●	💡	24V	[C]			2 pol. ASS3	♀			1,75 m	
31-3604-044	1/-		●	💡	24V	[D]			P&R				1,40 m	
31-3606-004	1/-		●	💡	24V	[D]			2 pol. ASS2	♀			1,75 m	
31-3608-004	1/-		●	💡	24V	[D]			offenes Ende				0,45 m	
31-3604-054	1/-	●		💡	24V	[D]			P&R				1,40 m	
31-3605-004	1/-	●		💡	24V	[D]			2 pol. ASS2	♀			1,70 m	
31-3608-014	1/-	●		💡	24V	[D]			offenes Ende				0,45 m	



SUPERPOINT II

ZUBEHÖR / ACCESSORIES

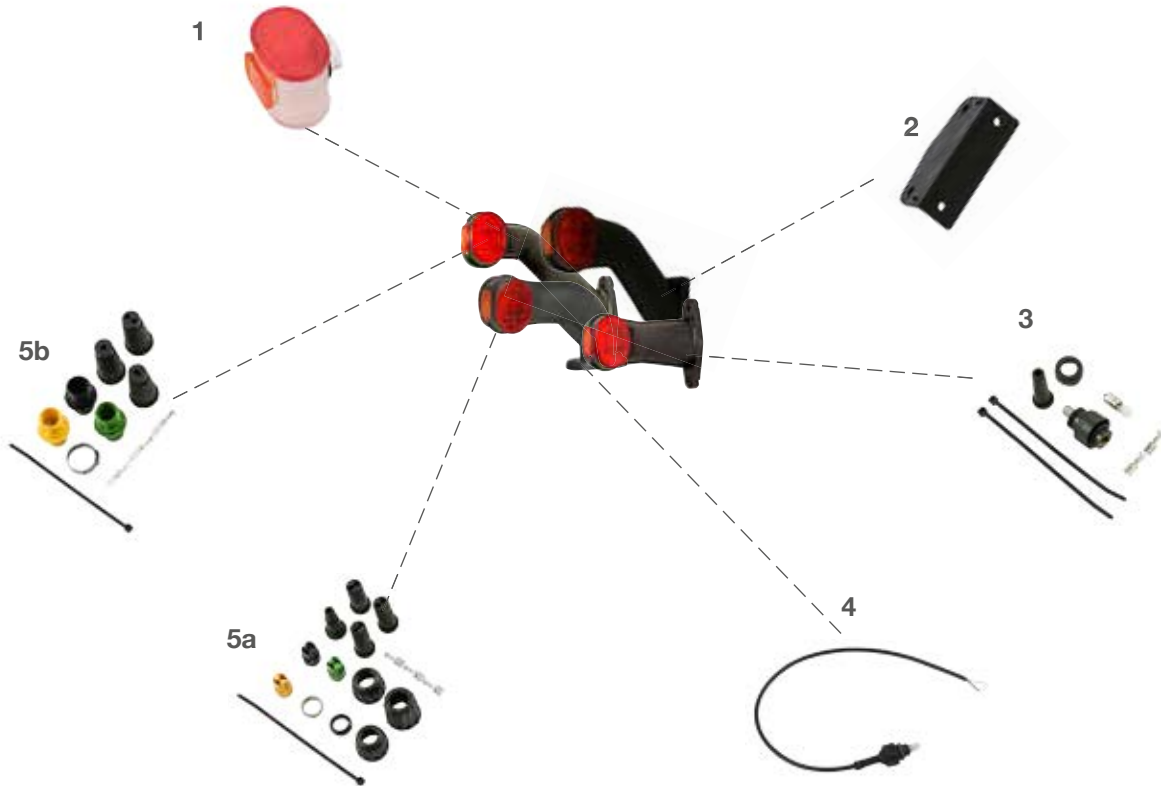

1 Lichtscheibe | lens
rot/weiß/orange
red/white/orange
..... 18-8136-014

2 Befestigungswinkel für Leuchtarm |
angle bracket for end outline marker
..... 15-5313-004

3 gerade Anschluss | straight connector
..... 15-2128-544

4 Glühlampenanschluss | bulb connection
inkl. Glühlampe und 0,5 m Kabel
including bulb and 0,5 m cable
..... 31-2800-004

5 ASS1 & ASS2 Verbinder |
ASS1 & ASS2 connector
(a) 2 pol. weiblich
2 pin female 13-5626-401
(b) 2 pol. männlich
2 pin male 13-5625-991





SUPERPOINT II

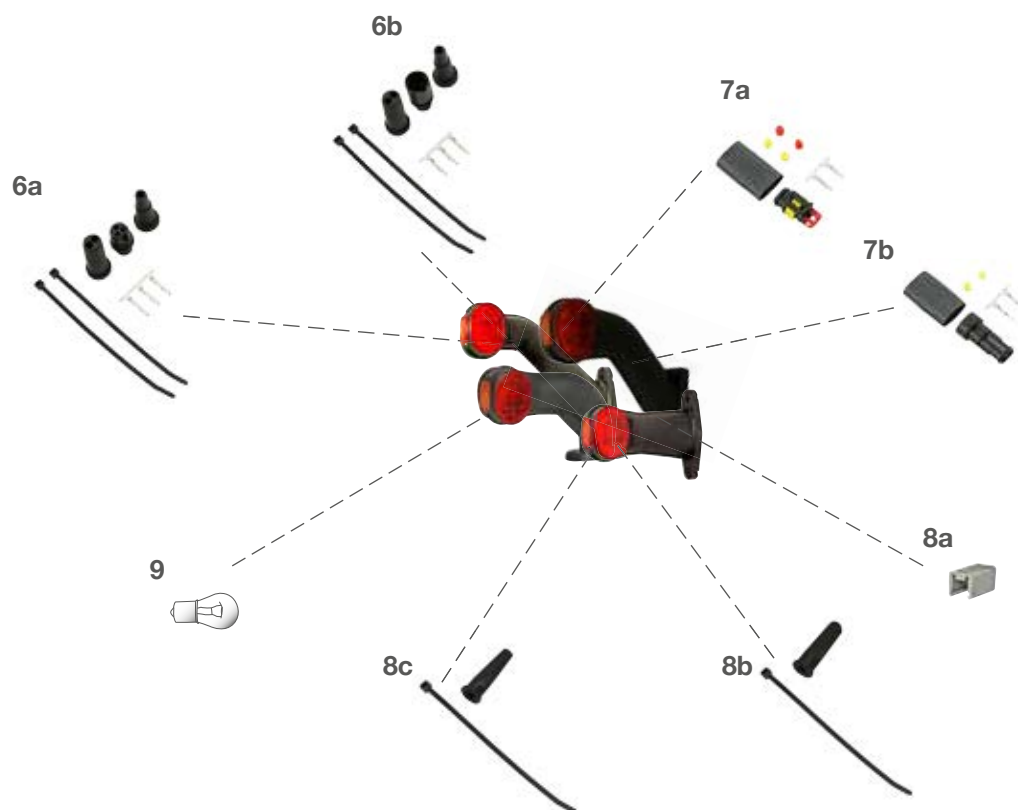

ZUBEHÖHR / ACCESSORIES



6 ASS3 Verbinder | ASS3 connector

- (a) 3 pol. weiblich
3 pin female 13-0322-281 
- (b) 3 pol. männlich
3 pin male 13-0332-281 

7 Superseal Verbinder | Superseal connector

- (a) 2 pol. weiblich
2 pin female 15-7002-044 
- (b) 2 pol. männlich
2 pin male 15-7002-054 

8 für P&R Verbinder | for P&R connector

- (a) Verschlusskappen
caps 15-5971-014 
- (b) Endkappen rund
end caps round 15-5983-024 
- (c) Endkappen eckig
end caps square 15-5729-014 

9 Glühlampe | bulb

- 24V 4W 16-6304-027 



SPÖCK®

S T E M S



ERSATZTEILE | SPARE PARTS

POSITIONSLEUCHE

Die Positionsleuchten von Aspöck erfüllen, je nach Farbwahl der Lichtscheibe unterschiedliche Funktionen. Diese Leuchten im einheitlichen Design können entweder direkt oder mit Halter montiert werden und zeichnen sich durch universelle Anschlüsse aus.

POSITION LAMP

Depending on the selected colour of lens, the position lights by Aspöck have different functions. These lamps in uniform design can either be directly attached or attached with a bracket, and are characterised by their universal connections.

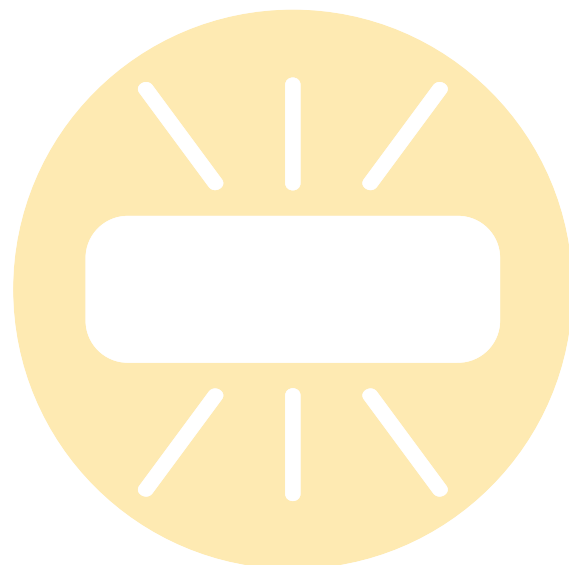



FLATPOINT II LED

ADR Zone 2 IP69K

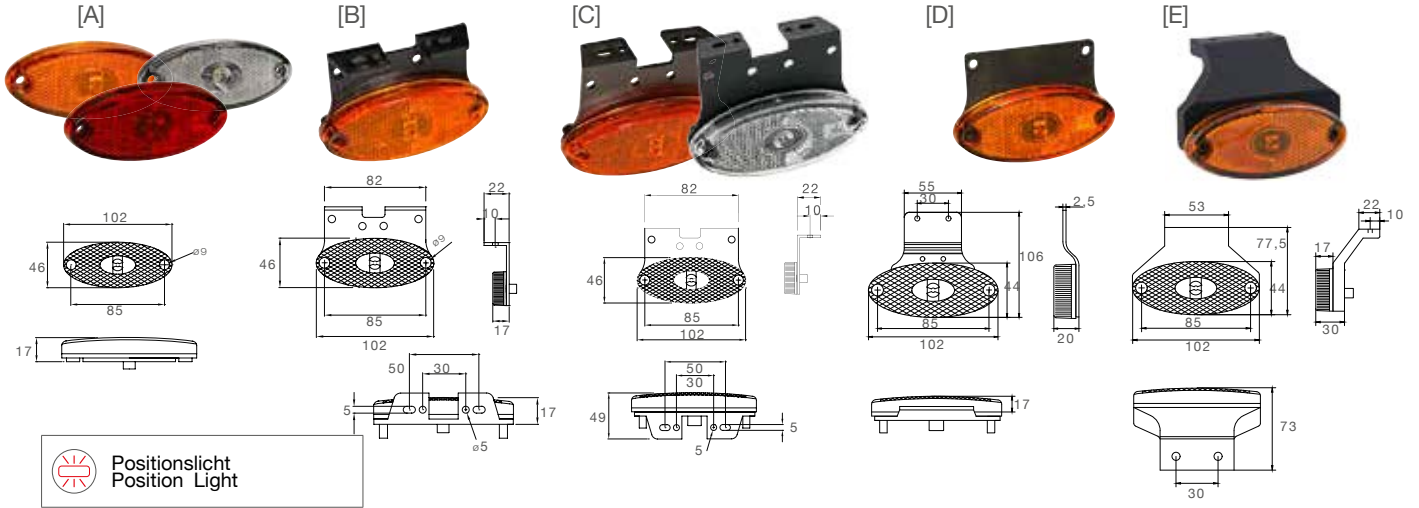

BEST. NR				ZUSATZ	ANSCHLUSS		
PART NO				ADD ON	CONNECTOR		
31-2304-014	1/-	LED	24V	[A] Bild	P&R		0,50 m
31-2304-034	1/-	LED	24V	[A] Bild	P&R		1,50 m
31-2304-044	1/-	LED	24V	[A] Bild	P&R		2,00 m
31-2304-094	1/-	LED	12V 24V	[A] Bild	P&R		1,50 m
31-2304-104	-/-	LED	12V 24V	[A] Bild	P&R		0,50 m
31-2307-004	-/-	LED	24V	[A] Bild	2 pol. ASS3 2 pin ASS3		0,50 m
31-2307-014	-/-	LED	24V	[A] Bild	2 pol. ASS3 2 pin ASS3		1,50 m
31-2307-034	-/-	LED	24V	[A] Bild	2 pol. ASS3 2 pin ASS3		1,00 m
31-2364-014	1/-	LED	24V	[B] Bild	P&R		0,50 m
31-2364-024	1/-	LED	24V	[B] Bild	P&R		1,00 m
31-2364-034	1/-	LED	24V	[B] Bild	P&R		1,50 m
31-2364-084	1/-	LED	24V	[C] Bild	P&R		0,50 m
31-2364-104	1/-	LED	24V	[C] Bild	P&R		1,50 m
31-2364-114	1/-	LED	24V	[C] Bild	P&R		2,00 m
31-2364-134	-/-	LED	24V	[D] Bild	P&R		0,25 m
31-2364-284	-/-	LED	24V	[D] Bild	P&R		1,50 m
31-2364-184	1/-	LED	24V	[E] Bild	P&R		1,50 m
31-2364-304	1/-	LED	24V	[F] Bild	P&R		0,25 m



FLATPOINT II LED

ADR Zone 2 IP69K

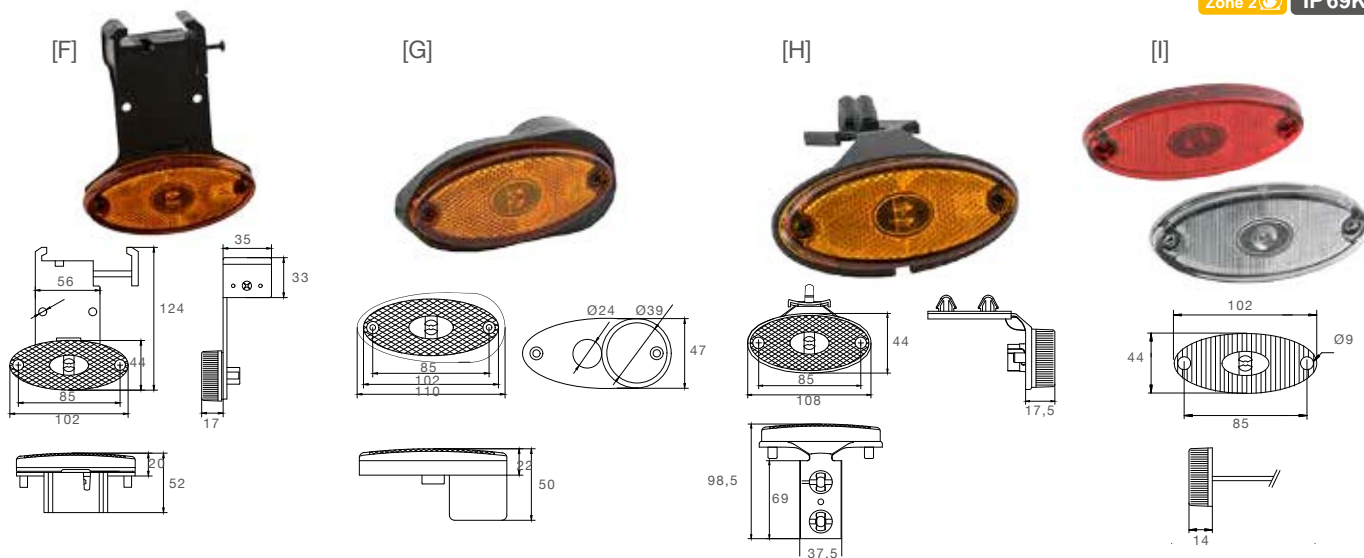

Positionslampe
Position Lamp

BEST. NR				ZUSATZ	ANSCHLUSS		
PART NO				ADD ON	CONNECTOR		
31-2364-324	1/-	LED	24V	[G] Bild	P&R		2,00 m
31-2364-334	1/-	LED	24V	[H] Bild	P&R		1,50 m
31-2364-344	1/-	LED	24V	[H] Bild	P&R		1,00 m
31-2364-354	-/-	LED	24V	[H] Bild	P&R		2,00 m
31-2367-034	1/-	LED	24V	[C] Bild	2 pol. ASS3 2 pin ASS3		1,50 m
31-2367-054	-/-	LED	24V	[B] Bild	2 pol. ASS3 2 pin ASS3		1,50 m
31-2367-064	-/-	LED	24V	[H] Bild	2 pol. ASS3 2 pin ASS3		1,50 m
31-6900-014	1/-	LED	24V	[A] Bild	offenes Ende open end		0,50 m
31-6904-014	1/-	LED	24V	[A] Bild	P&R		0,50 m
31-6904-034	1/-	LED	24V	[A] Bild	P&R		1,50 m
31-6904-054	1/-	LED	24V	[A] Bild	P&R		3,50 m
31-6904-124	1/-	LED	24V	[I] Bild	P&R		3,50 m
31-6904-164	-/-	LED	12V 24V	[A] Bild	P&R		1,50 m
31-6907-034	-/-	LED	24V	[A] Bild	2 pol. ASS3 2 pin ASS3		1,50 m
31-6964-004	-/-	LED	24V	[C] Bild	P&R		1,50 m
31-6404-014	1/-	LED	24V	[A] Bild	P&R		0,50 m
31-6404-094	1/-	LED	24V	[I] Bild	P&R		0,50 m
31-6404-124	1/-	LED	24V	[I] Bild	P&R		3,50 m



FLATPOINT II LED

ZUBEHÖHR / ACCESSORIES

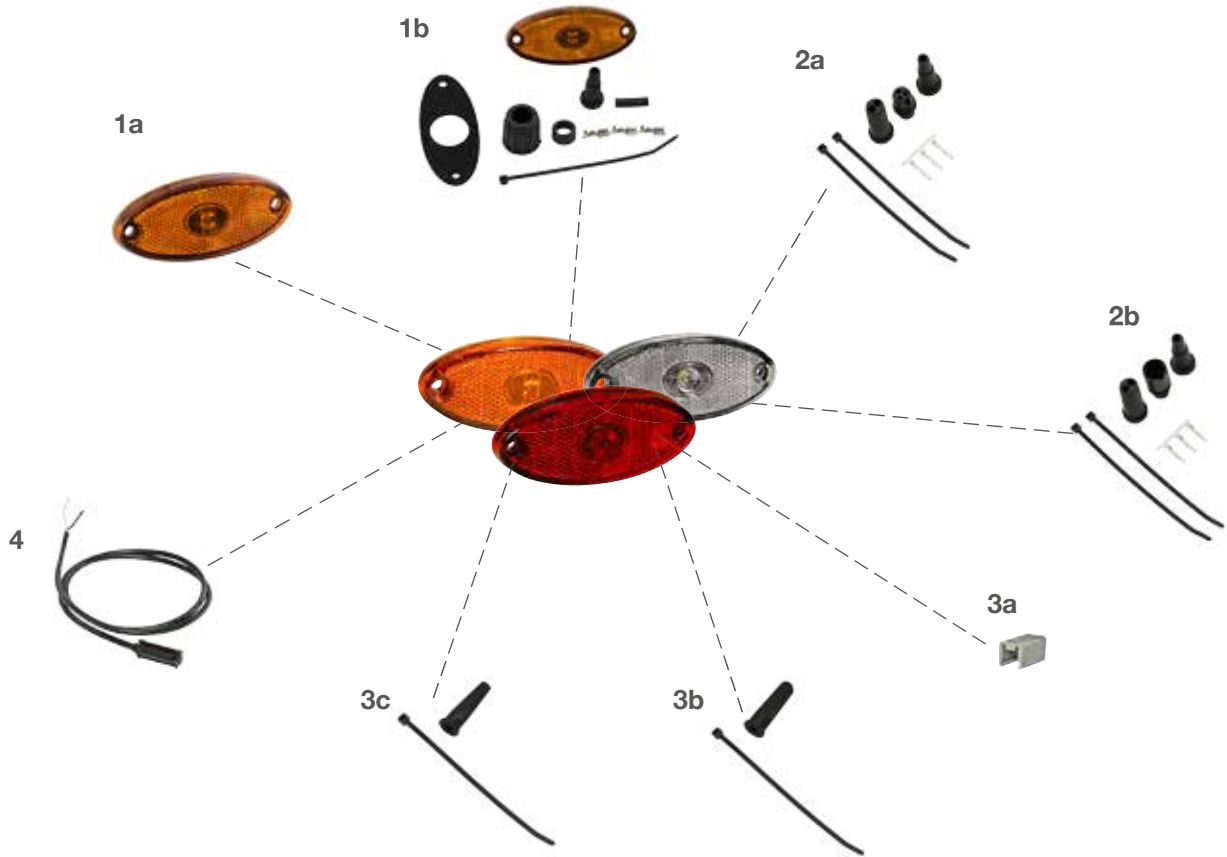

1 Ersatzleuchte orange | spare part lamp orange

- (a) lose
loose..... 21-2303-004
- (b) mit Bajonett- Mutter
with bayonet-nut 21-2302-004 

2 ASS3 Verbinder | ASS3 connector

- (a) 3 pol. weiblich
3 pin female 13-0322-281 
- (b) 3 pol. männlich
3 pin male 13-0332-281 

3 für P&R Verbinder | for P&R connector

- (a) Verschlusskappen
caps..... 15-5971-014 
- (b) Endkappen rund
end caps round..... 15-5983-024 
- (c) Endkappen eckig
end caps square..... 15-5729-014 

4 Anschlusskabel P&R | connection cable P&R



- 0,5 m..... 68-5000-014 
- 1,5 m..... 68-5000-034 

FLATPOINT II LED

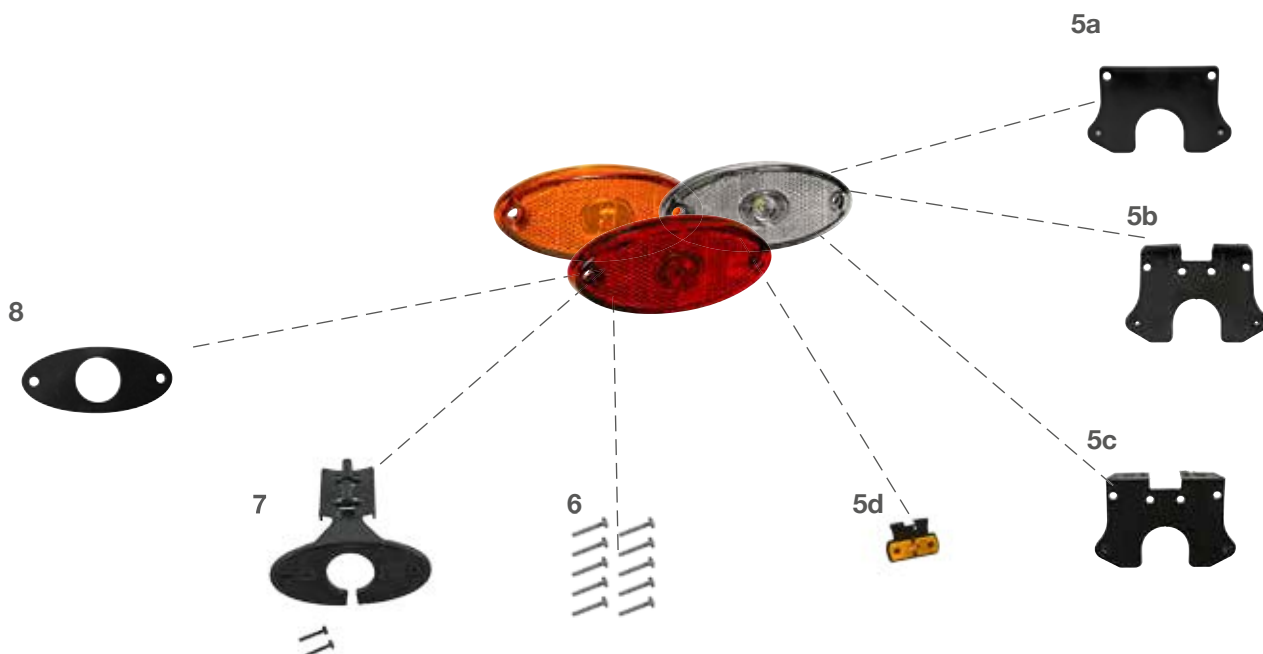
ZUBEHÖHR / ACCESSORIES



5 Haltewinkel | bracket

- (a) gerade
straight 15-5321-004
- (b) 90° nach vorne
90° to the front..... 15-5321-104 
- (c) 90° nach hinten
90° to the back..... 15-5321-204 
- (d) schräg 90° nach hinten
sloping 90° to the back
..... 15-5321-204 

6 Schrauben für Haltewinkel 10 screws for bracketangle

..... 14-0418-304

7 Schnellhalter + Schrauben quick-fixation bracket +screws

..... 15-7321-234 

8 Gummiunterlage | rubber base

..... 15-5111-004





FLATPOINT I LED

ADR Zone 2

IP 68

[A]

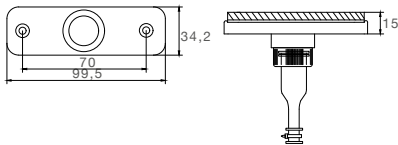

[B]

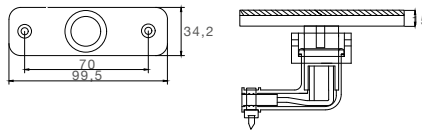

[C]

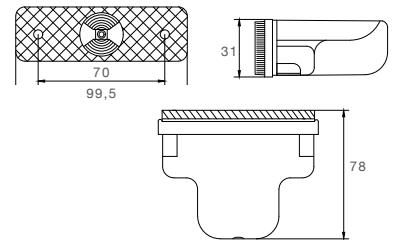

BEST. NR				ZUSATZ				ANSCHLUSS
PART NO				ADD ON				CONNECTOR
31-6604-014	1/-	LED	24V	[A] Bild				P&R 0,50 m
31-6604-034	1/-	LED	24V	[A]				P&R 1,50 m
31-6604-074	1/-	LED	24V	[B] Bild				P&R 0,50 m
31-6604-094	1/-	LED	24V	[B]				P&R 1,50 m
31-6604-114	-/-	LED	24V	[B]				P&R 3,50 m
31-6607-004	-/-	LED	24V	[B] Bild				2 pol. ASS2 1,50 m
31-6607-054	-/-	LED	24V	[A] Bild				2 pol. ASS3 1,50 m
31-6614-014	1/-	LED	24V	[C] Bild			Schutzhaube protection cap	P&R 0,50 m
31-6614-034	1/-	LED	24V	[C]			Schutzhaube protection cap	P&R 1,50 m
31-6614-074	1/-	LED	24V	[D] Bild			Schutzhaube protection cap	P&R 0,50 m
31-6614-094	1/-	LED	24V	[D]			Schutzhaube protection cap	P&R 1,50 m
31-6664-014	1/-	LED	24V	[E] Bild			Schutzhaube protection cap	P&R 0,50 m
31-6664-031	1/-	LED	24V	[E]			Schutzhaube protection cap	P&R 1,50 m
31-6667-014	-/-	LED	24V	[D] Bild			Schutzhaube protection cap	2 pol. ASS3 0,50 m



FLATPOINT I LED

ADR Zone 2

IP 68

[D]

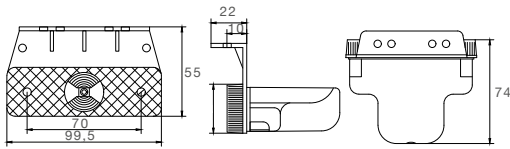

[E]

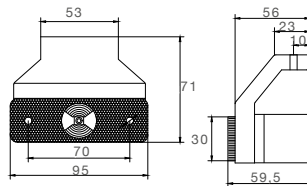

[F]

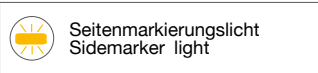
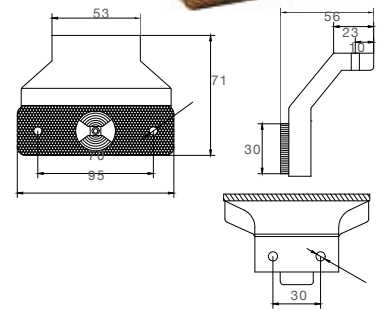

Positionslampe
Position Lamp

BEST. NR PART NO				ZUSATZ ADD ON	ANSCHLUSS CONNECTOR	
31-2204-014	1/-	LED	24V	[A] Bild	P&R	0,50 m
31-2214-004	1/-	LED	24V	[D] Bild Schutzhaube protection cap	P&R	0,25 m
31-2214-014	1/-	LED	24V	[D] Schutzhaube protection cap	P&R	0,50 m
31-2214-024	1/-	LED	24V	[D] Schutzhaube protection cap	P&R	1,00 m
31-2214-034	1/-	LED	24V	[D] Schutzhaube protection cap	P&R	1,50 m
31-2214-114	1/-	LED	24V	[C] Schutzhaube protection cap	P&R	0,50 m
31-2214-134	1/-	LED	24V	[C] Schutzhaube protection cap	P&R	1,50 m
31-2264-014	1/-	LED	24V	[F] Bild	P&R	0,50 m
31-2264-024	1/-	LED	24V	[F]	P&R	1,00 m
31-2264-034	1/-	LED	24V	[F]	P&R	1,50 m
31-2267-014	1/-	LED	24V	[E] Bild Schutzhaube protection cap	2 pol. ASS2 2 pin ASS2	1,00 m
31-2267-064	-/-	LED	24V	[C] Bild Schutzhaube protection cap	3 pol. ASS3 3 pin ASS3	1,50 m
31-2267-074	-/-	LED	24V	[D] Bild Schutzhaube protection cap	3 pol. ASS3 3 pin ASS3	1,50 m
31-2267-084	-/-	LED	24V	[E] Bild Schutzhaube protection cap	3 pol. ASS3 3 pin ASS3	1,50 m



FLATPOINT I LED

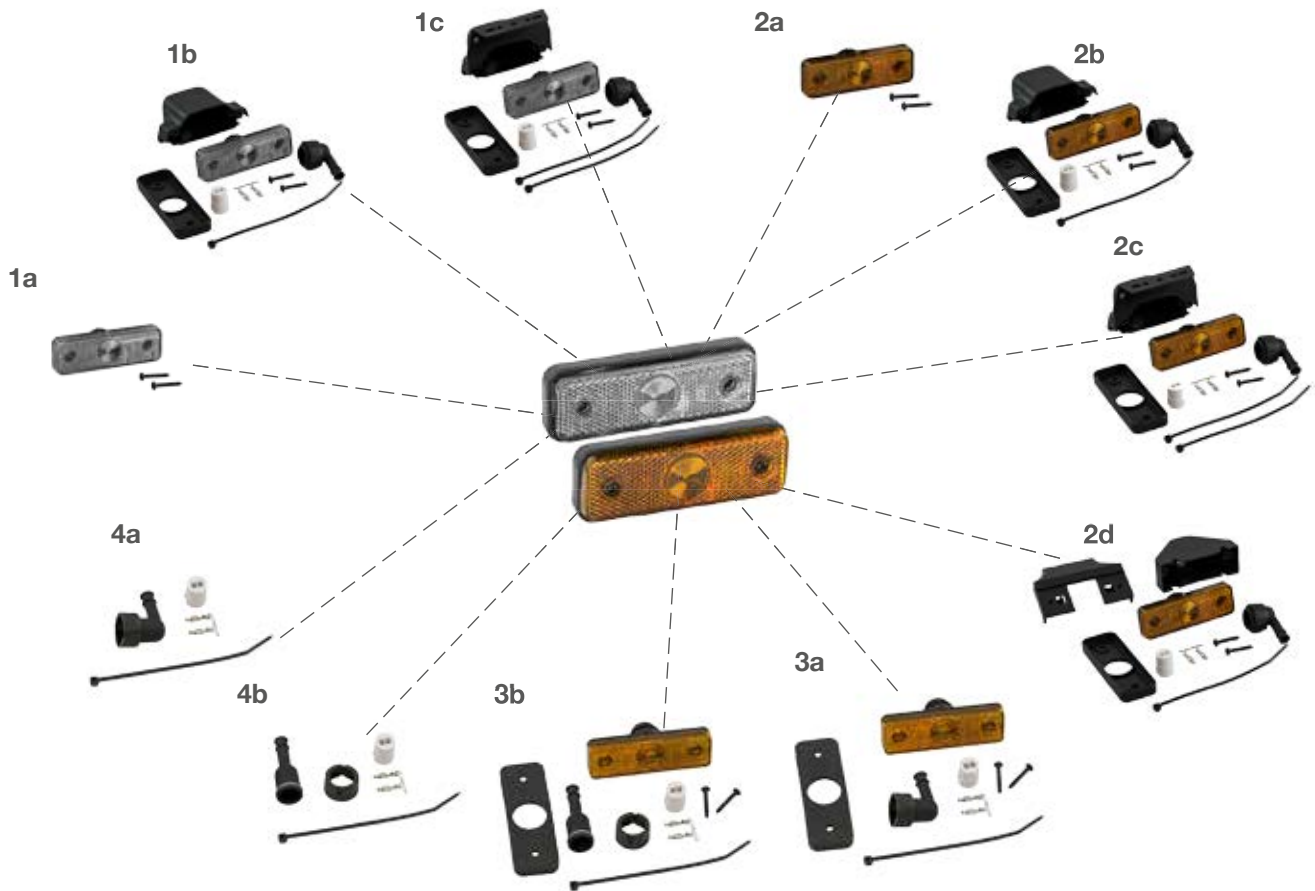

1 Ersatzleuchte weiß mit Schutzhaube | spare part lamp white with protection cap

- (a) mit Schrauben
with screws..... 21-6600-014
- (b) mit 90° Anschluss ohne Haltewinkel
with 90° connector without bracket
..... 21-6601-004
- (c) mit 90° Anschluss und 90° Haltewinkel
with 90° connector and 90° bracket
..... 21-6600-004

2 Ersatzleuchte orange mit Schutzhaube | spare part lamp orange with protection cap

- (a) mit Schrauben
with screws..... 21-2200-004
- (b) mit 90° Anschluss ohne Haltewinkel
with 90° connector without bracket
..... 21-2201-004
- (c) mit 90° Anschluss und 90° Haltewinkel
with 90° connector and 90° bracket
..... 21-2200-014
- (d) mit 90° Anschluss und 90° Haltewinkel schräg
with 90° connector and sloping 90° bracket
..... 21-2202-004

3 Ersatzleuchte orange ohne Schutzhaube | spare part lamp orange without protection cap

- (a) mit 90° Anschluss
with 90° connector
..... 21-2201-014
- (b) mit geradem Anschluss
with straight connector
..... 21-2201-044

4 Anschluss | connector

- (a) 90° gewinkelt
angled connection 90°
..... 15-2122-104
- (b) gerade komplett
straight bracket complete
..... 15-2122-124

5 ASS1 & ASS2 Verbinder | ASS1 & ASS2 connector

- (a) 2 pol. männlich
2 pin male 13-5625-991
- (b) 2 pol. weiblich
2 pin female 13-5626-401





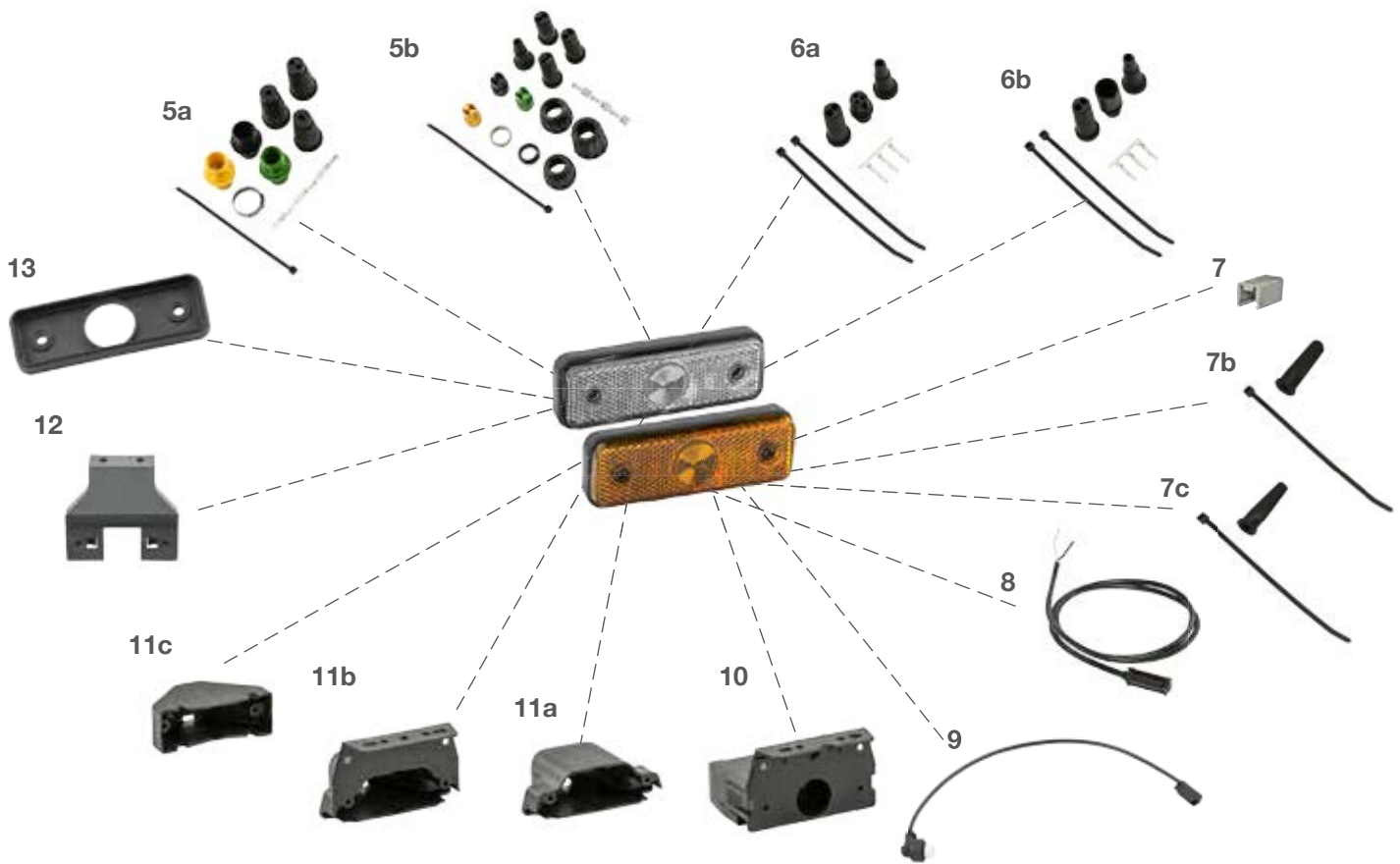

FLATPOINT I LED

ZUBEHÖHR / ACCESSORIES



6 ASS3 Verbinder | ASS3 connector

- (a) 3 pol. weiblich
3 pin female 13-0322-281 
- (b) 3 pol. männlich
3 pin male 13-0332-281 

7 für P&R Verbinder | for P&R connector

- (a) Verschlusskappen
caps 15-5971-014 
- (b) Endkappen rund
end caps round 15-5983-024 
- (c) Endkappen eckig
end caps square 15-5729-014 

8 Anschlusskabel P&R | connection cable P&R

- 0,50 m 68-5000-014 
- 1,50 m 68-5000-034 



9 Zuleitung P&R | front connection P&R

- 0,50 m 31-2204-154

10 Sockel mit Haltewinkel und Schutzhaube | socket with bracket and protection cap

- 15-2128-274 

11 Schutzhaube | protection cap

- (a) ohne Haltewinkel
without bracket 15-2122-164 
- (b) mit 90° Haltewinkel
with 90° bracket 15-2122-174 
- (c) für schrägen Haltewinkel
for sloping bracket 15-2128-094 

12 Haltewinkel | bracket

- schräg
sloping 15-2128-144 

13 Gummiauflage | rubber base

- 11-2128-194 





UNIPOINT II LED

ADR Zone 2 IP 6K9K



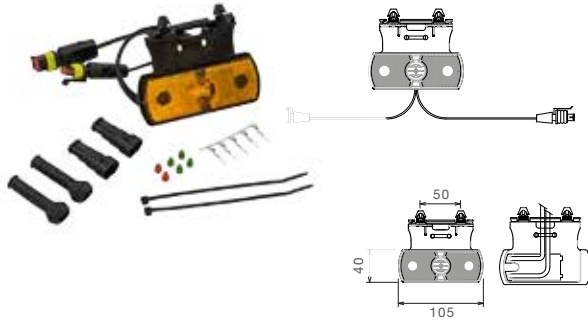



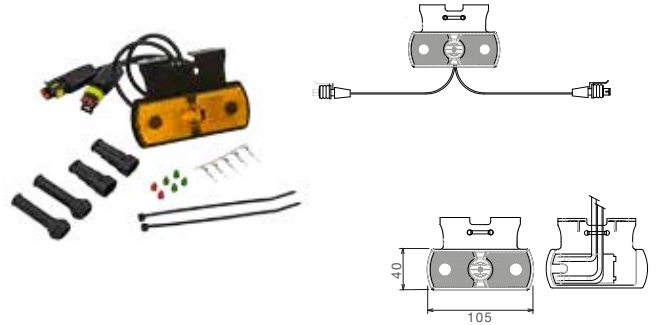



[A]



[B]



Seitenmarkierungslicht
Sidemarker light

BEST. NR				ZUSATZ	ANSCHLUSS
PART NO				ADD ON	CONNECTOR
31-2464-024	1/-	LED	24V	[A]  	2 x 2 pol. Superseal 2 x 2 pin Superseal ♀   0,40 m 
31-2464-034	1/-	LED	24V	[B]  	2 x 2 pol. Superseal 2 x 2 pin Superseal ♀   0,40 m 









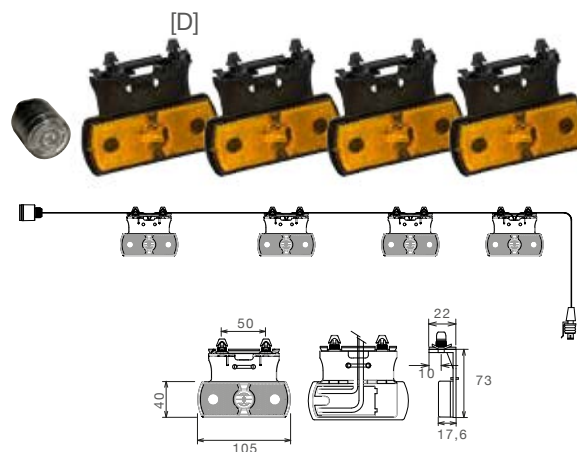
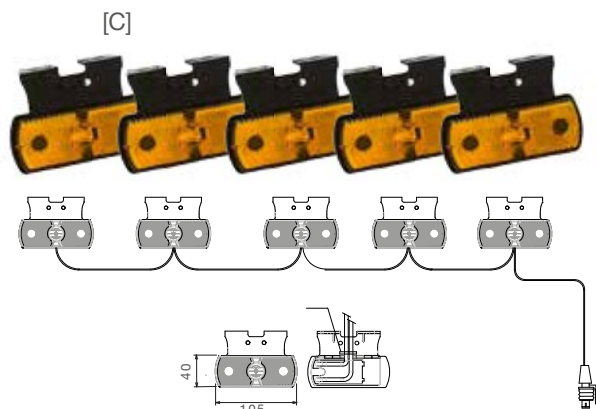







UNIPOINT II LED

ZUBEHÖHR / ACCESSORIES

ADR Zone 2 IP 6K9K





 Seitenmarkierungslicht
Sidemarker light

BEST. NR PART NO				ZUSATZ ADD ON	ANSCHLUSS CONNECTOR
87-1364-001	1/-	LED	24V	[C]  	2 pol. Superseal 2 pin Superseal   2,20 m 
87-1366-011	-/-	LED	24V	[D]  	2 pol. Superseal 2 pin Superseal   6,04 m 



ZUBEHÖHR / ACCESSORIES

1 Superseal Verbinder | Superseal connector

- (a) 2 pol. weiblich
2 pin female 15-7002-044 
- (b) 2 pol. männlich
2 pin male 15-7002-054 

1a



1b





UNIPOINT I LED

ADR Zone 2 IP 6K9K

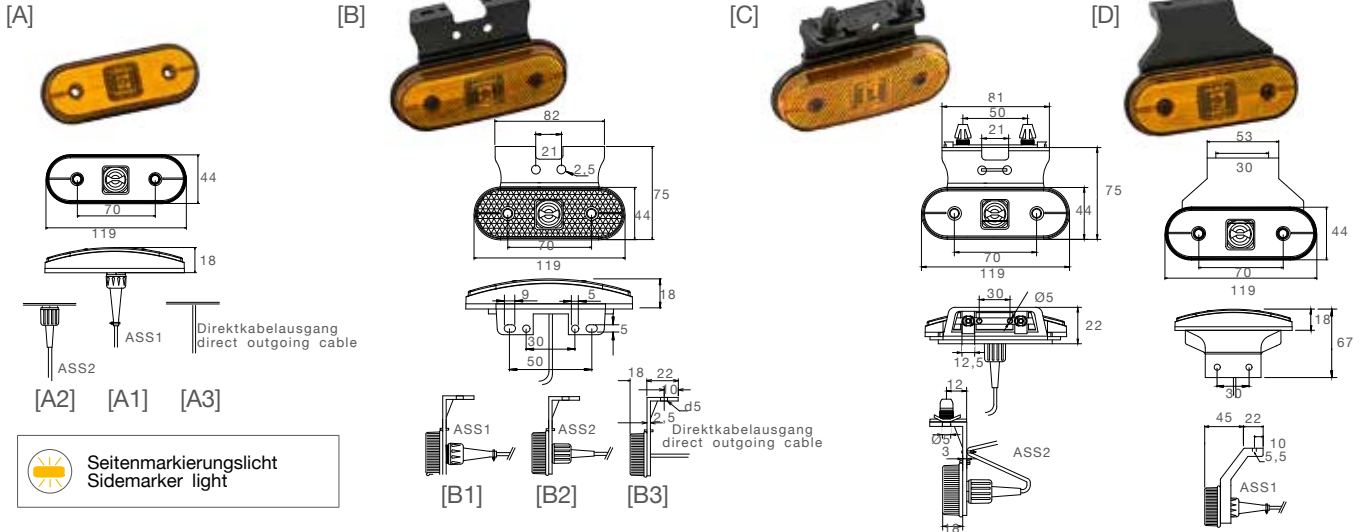

BEST. NR PART NO				ZUSATZ ADD ON	ANSCHLUSS CONNECTOR
31-2000-014	-/-	LED	24V	[A3]	offenes Ende open end 0,50 m
31-2000-034	-/-	LED	24V	[A3]	offenes Ende open end 1,50 m
31-2004-014	1/-	LED	24V	[A1]	P&R 0,50 m
31-2004-034	1/-	LED	24V	[A1]	P&R 1,50 m
31-2004-044	1/-	LED	24V	[A1]	P&R 2,00 m
31-2004-074	-/-	LED	24V	[A1]	P&R 2,50 m
31-2007-024	-/-	LED	24V	[A2]	2 pol. ASS2 2 pin ASS2 1,00 m
31-2007-234	1/-	LED	24V	[A2]	3 pol. ASS3 3 pin ASS3 0,50 m
31-2007-244	1/-	LED	24V	[A2]	3 pol. ASS3 3 pin ASS3 1,50 m
31-2007-294	1/-	LED	24V	[A2]	2 pol. ASS2 2 pin ASS2 2,00 m
31-2007-304	1/-	LED	24V	[A3]	3 pol. ASS3 3 pin ASS3 0,50 m
31-2007-334	1/-	LED	24V	[A3]	3 pol. ASS3 3 pin ASS3 1,50 m
31-2007-344	-/-	LED	24V	[A3]	2 pol. ASS2 2 pin ASS2 0,50 m
31-2064-014	1/-	LED	24V	[B1]	P&R 0,50 m
31-2064-034	1/-	LED	24V	[B1]	P&R 1,50 m
31-2064-124	1/-	LED	24V	[C]	P&R 2,00 m
31-2064-214	1/-	LED	24V	[D]	P&R 0,50 m





UNIPOINT I LED

ADR Zone 2 IP 6K9K

[E]

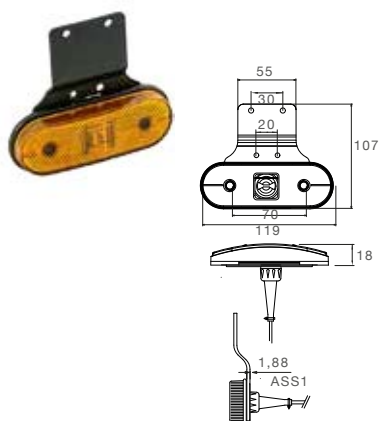

[F]

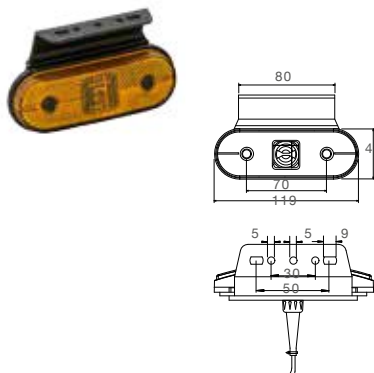

[G]

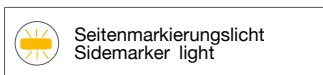
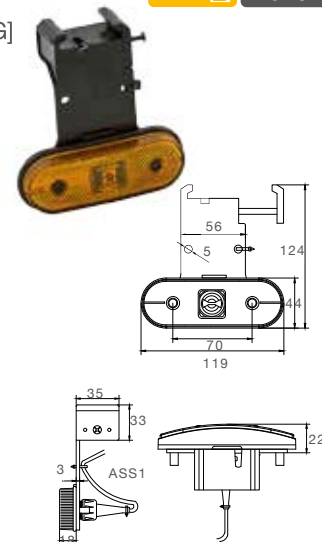

[F1]

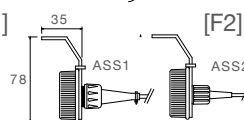

[F2]

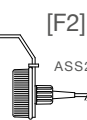

BEST. NR PART NO				ZUSATZ ADD ON	ANSCHLUSS CONNECTOR		
31-2064-234	1/-	LED	24V	[D]	P&R		1,50 m
31-2064-414	1/-	LED	24V	[E]	P&R		0,50 m
31-2064-434	1/-	LED	24V	[E]	P&R		1,50 m
31-2064-714	1/-	LED	24V	[F1]	P&R		0,50 m
31-2064-734	1/-	LED	24V	[F1]	P&R		1,50 m
31-2064-774	1/-	LED	24V	[G]	P&R		1,00 m
31-2067-084	-/-	LED	24V	[B2]	2 pol. ASS2 2 pin ASS2		1,50 m
31-2067-094	1/-	LED	24V	[B2]	3 pol. ASS3 3 pin ASS3		0,50 m
31-2067-104	1/-	LED	24V	[B2]	3 pol. ASS3 3 pin ASS3		1,50 m
31-2067-694	-/-	LED	24V	[F2]	3 pol. ASS3 3 pin ASS3		1,50 m
31-2104-014	1/-	LED	24V	[A]	P&R		0,50 m
31-2104-034	1/-	LED	24V	[A]	P&R		1,50 m
31-2164-014	1/-	LED	24V	[B3]	P&R		0,50 m
31-2164-034	-/-	LED	24V	[B3]	P&R		1,50 m





UNIPOINT I LED

ADR Zone 2 IP 6K9K

[H]

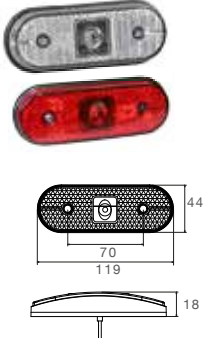

[I]

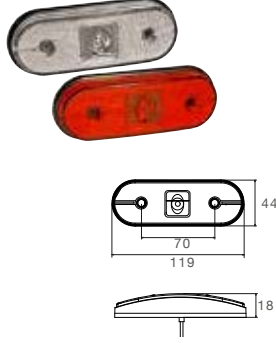

[J]

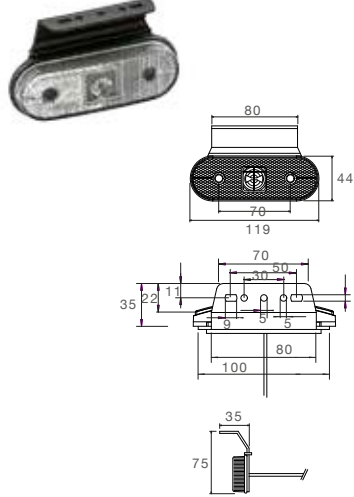

[K]

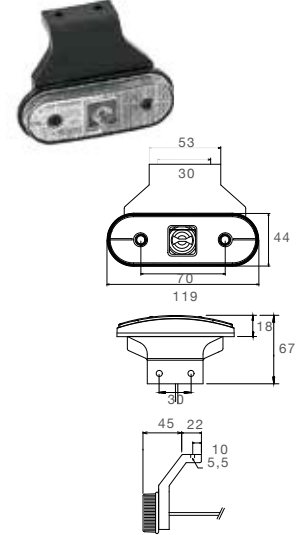

Positionslicht
Position Light

BEST. NR PART NO				ZUSATZ ADD ON			ANSCHLUSS CONNECTOR						
				[H]	[I]	[J]	[K]	Symbol	Symbol	Symbol	Symbol		
31-7704-014	1/-	LED	24V	[H]					P&R			0,50 m	
31-7704-034	1/-	LED	24V	[H]					P&R			1,50 m	
31-7704-054	1/-	LED	24V	[H]					P&R			3,50 m	
31-7704-094	1/-	LED	24V	[I]					P&R			0,50 m	
31-7704-124	1/-	LED	24V	[I]					P&R			3,50 m	
31-7707-034	1/-	LED	24V	[H]					2 pol. ASS2 2 pin ASS2			1,50 m	
31-7707-104	1/-	LED	24V	[H]					2 pol. ASS3 2 pin ASS3			0,50 m	
31-7707-114	1/-	LED	24V	[H]					2 pol. ASS3 2 pin ASS3			1,50 m	
31-7707-214	-/-	LED	24V	[H]					2 pol. ASS2 2 pin ASS2			0,50 m	
31-7764-014	1/-	LED	24V	[J]					P&R			0,50 m	
31-7764-214	-/-	LED	24V	[K]					P&R			0,50 m	
31-7764-234	-/-	LED	24V	[K]					P&R			1,50 m	
31-7804-014	1/-	LED	24V	[H]					P&R			0,50 m	
31-7804-054	1/-	LED	24V	[H]					P&R			3,50 m	
31-7804-094	1/-	LED	24V	[I]					P&R			0,50 m	
31-7804-124	1/-	LED	24V	[I]					P&R			3,50 m	
31-7804-144	1/-	LED	24V	[H]					P&R			5,00 m	



UNIPOINT I LED

ZUBEHÖHR / ACCESSORIES

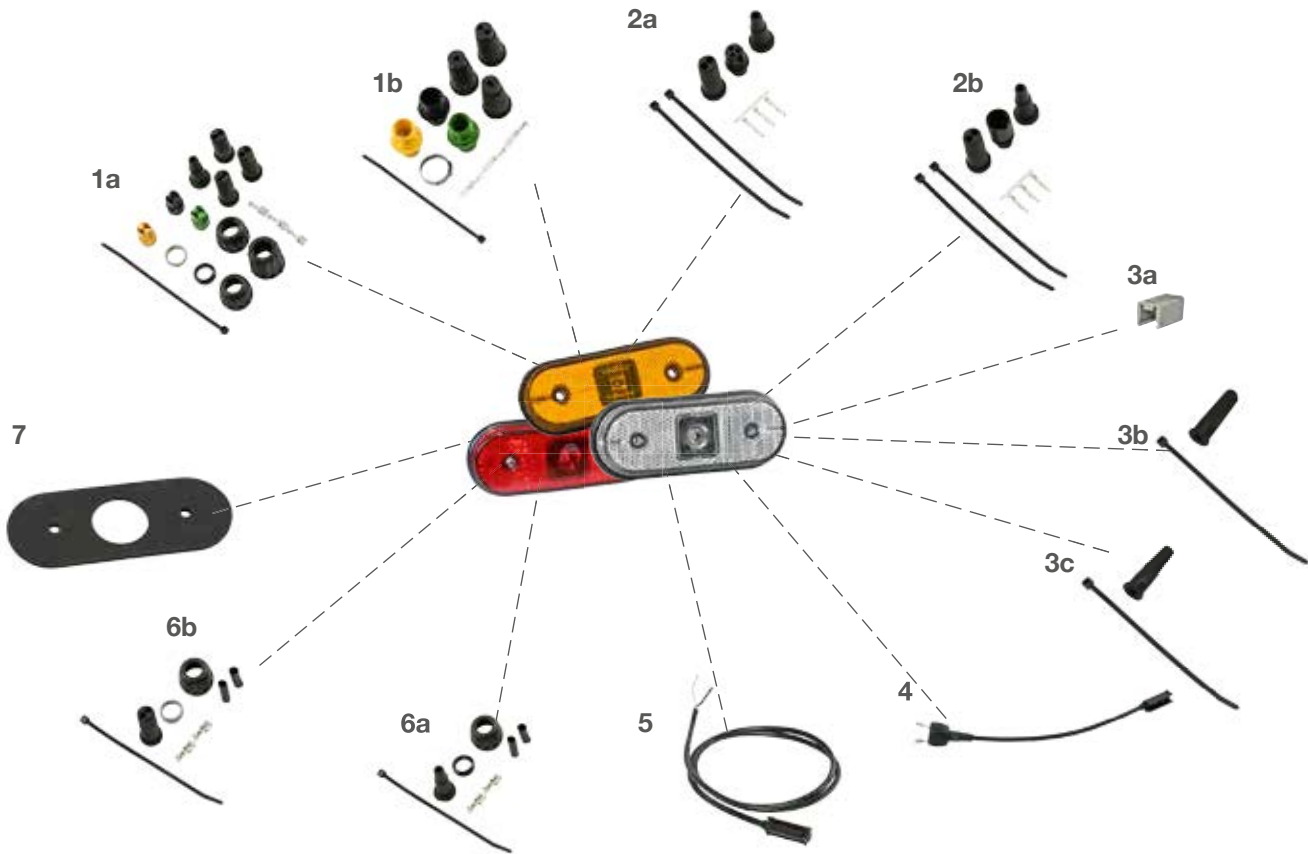

- 1 ASS1 & ASS2 Verbinder | ASS1 & ASS2 connector**
- (a) 2 pol. weiblich
2 pin female 13-5626-401
 - (b) 2 pol. männlich
2 pin male 13-5625-991

- 2 ASS3 Verbinder | ASS3 connector**
- (a) 3 pol. weiblich
3 pin female 13-0322-281
 - (b) 3 pol. männlich
3 pin male 13-0332-281

- 3 für P&R Verbinder | for P&R connector**
- (a) Verschlusskappen
caps 15-5971-014
 - (b) Endkappen rund
end caps round 15-5983-024
 - (c) Endkappen eckig
end caps square 15-5729-014

- 4 Zuleitung mit P&R Verbinder | front connection with P&R connector**
- 0,25 m 68-5018-004
 - 1,5 m 68-5018-024

- 5 Anschlusskabel P&R | connection cable P&R**
- 0,5 m 68-5000-014
 - 1,5 m 68-5000-034

- 6 Anschluss | connector**
- (a) Einfachtülle (lose)
single grommet (loose) 15-5624-014
 - (b) Doppeltülle (lose)
double grommet (loose) 15-5624-024

- 7 Gummiunterlage | rubber base**
- 15-5319-904





UNIPOINT I LED

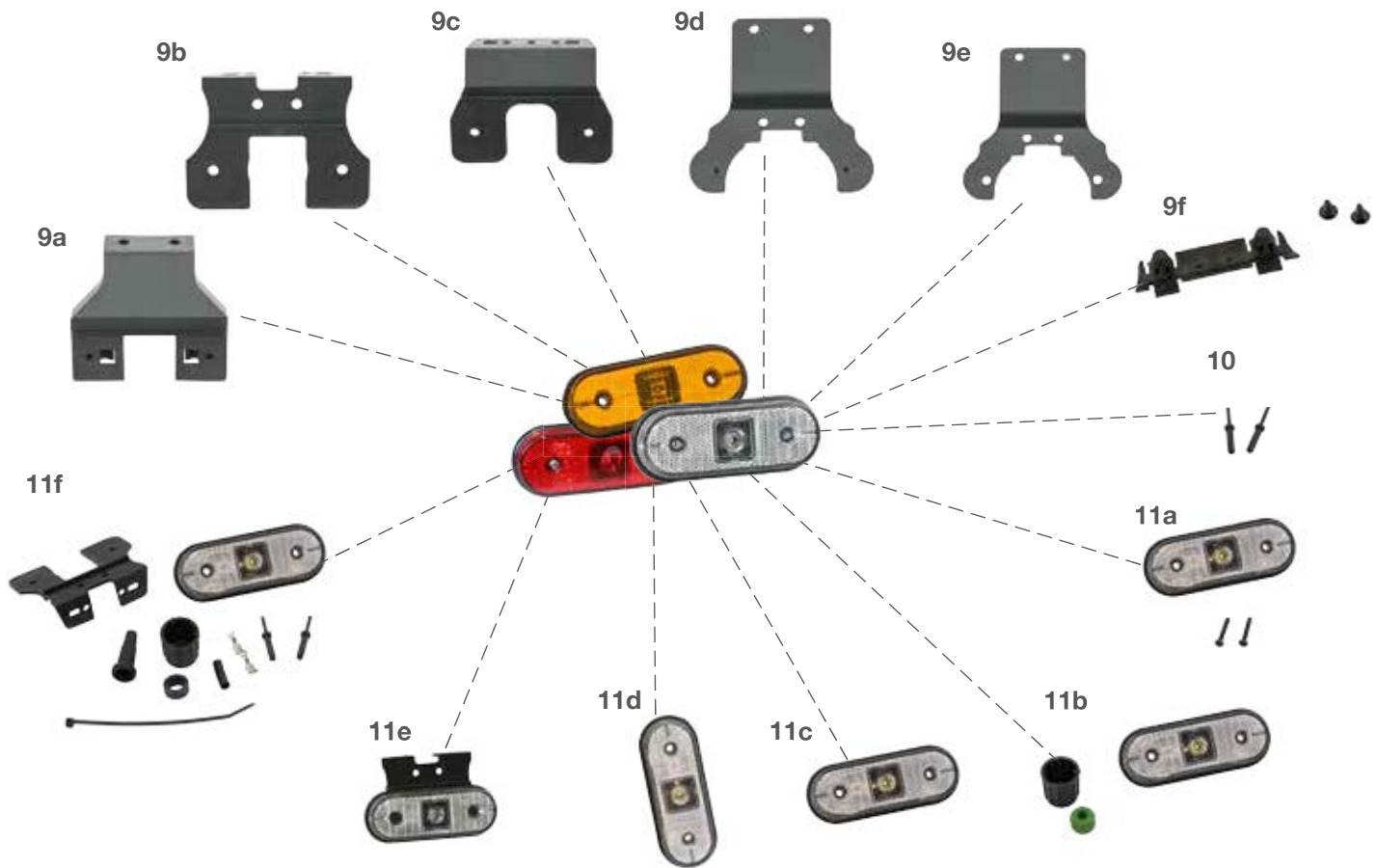

9 Haltewinkel | bracket

- (a) schräg nach hinten
sloping angle to the back
..... 15-5317-014
- (b) 90° nach hinten
90° to the back
..... 15-5319-004
- (c) schräg nach vorne
sloping to the front
..... 15-5319-304
- (d) Aufhängeteil gekröpft (Anbau mit Schrauben)
crumped bracket (screw mounting)
..... 15-5317-004
- (e) Aufhängeteil gekröpft (Anbau mit Nieten)
crumped bracket (expanding rivet-mounting)
..... 15-5317-024
- (f) Schnellhalter for SML
quick fixation bracket for SML
..... 15-2128-285

10 Spreizniete | expanding rivet

- 14-15 mm 14-4596-004

11 Ersatzleuchte weiß mit Schutzhaube | spare part lamp white with protection cap

- (a) mit Schrauben
with screws 21-7700-004
- (b) geschlossen mit Bajonett-Mutter
closed by bayonet-nut
..... 21-7700-014
- (c) Standard Version
standard version 21-7700-054
- (d) vertikal
vertical 21-7702-014
- (e) mit 90° Haltewinkel nach hinten
with 90° bracket to the back
..... 21-7700-024
- (f) mit 90° Haltewinkel nach hinten
(komplett)
with 90° bracket to the back
(complete)
..... 21-7700-035



UNIPOINT | LED

ZUBEHÖHR / ACCESSORIES

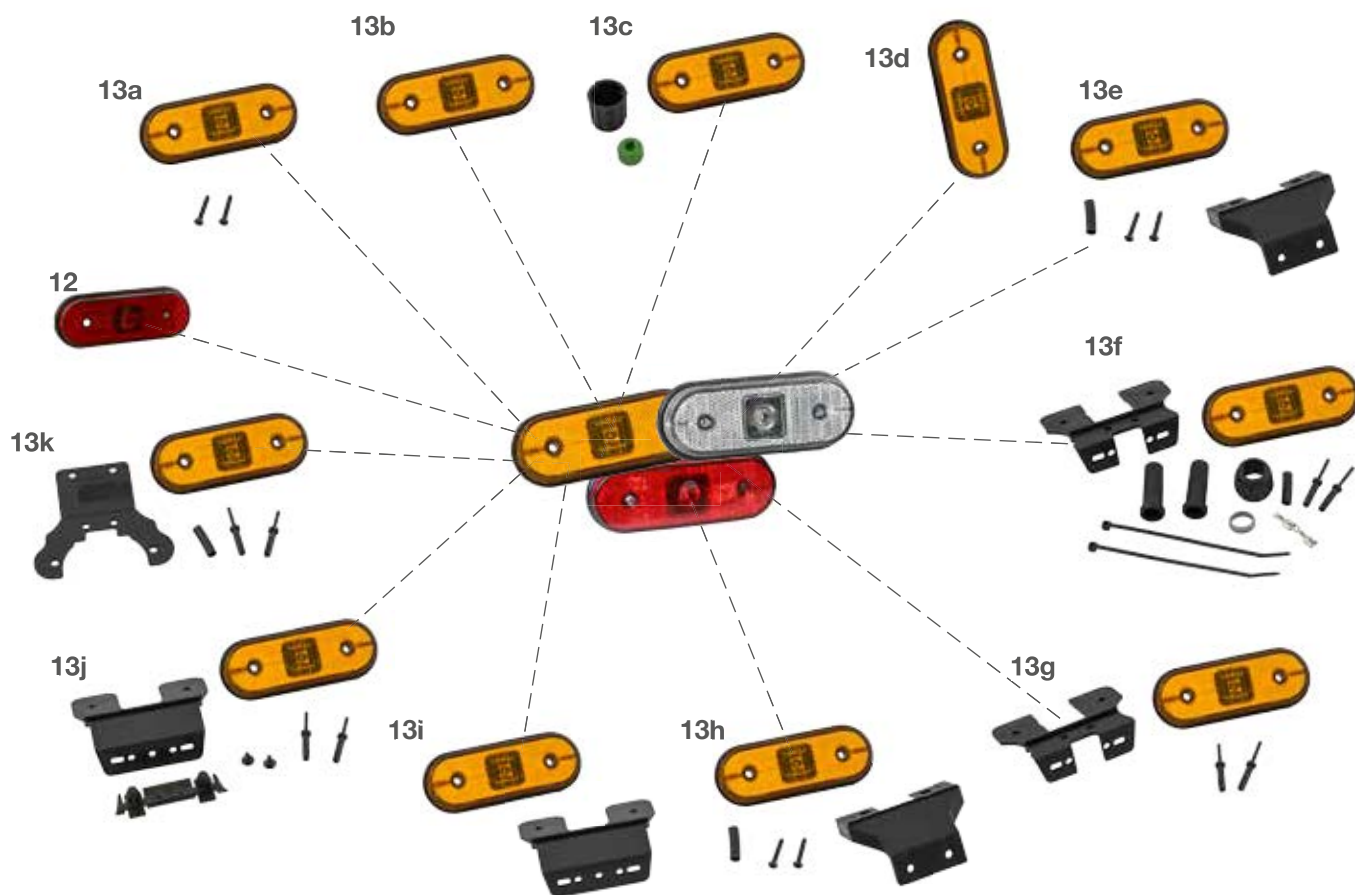

12 Ersatzleuchte rot mit Schutzhaube |
spare part lamp red with protection cap
mit Schrauben
with screws 21-7800-004

13 Ersatzleuchte orange mit Schutzhaube |
spare part lamp orange with protection cap

(a) mit Schrauben
with screws..... 21-2000-004

(b) ohne Schrauben
without screws..... 21-2000-154

(c) geschlossen mit Bajonett-Mutter
closed by bayonet-nut
..... 21-2000-144

(d) vertikal
vertical..... 21-2002-004

(e) mit geradem Anschluss für SML
with straight connector for SML
..... 21-2000-024

(f) mit geradem Anschluss für SML mit
90° Haltewinkel
with straight connector for SML with
90° bracket
..... 21-2000-035

(g) lose mit 90° Haltewinkel

loose with 90° bracket
..... 21-2000-014

(h) lose mit schrägen Haltewinkel
loose with sloping bracket
..... 21-2000-024

(i) mit flexiblen Haltewinkel
with flexible bracket
..... 21-2000-054

(j) mit flexiblen Haltewinkel und
Schnellhalter
with flexible bracket and quick-fixation bracket
..... 21-2000-104

(k) mit Aufhängeteil
with bracket..... 21-2000-064





SIDEPOINT

ADR
Zone 2

IP 68

[A]

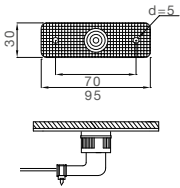

[B]

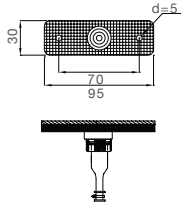

[C]

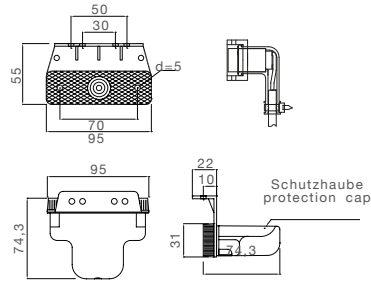

[D]

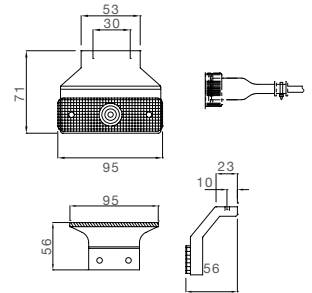

BEST. NR				ZUSATZ				ANSCHLUSS
PART NO				ADD ON				CONNECTOR
31-5004-014	-/-		24V	[A]				P&R 0,50 m
31-5004-094	1/-		24V	[B]				P&R 0,50 m
31-5004-104	1/-		24V	[B]				P&R 1,50 m
31-5004-154	1/-		24V	[A]				P&R 0,25 m
31-2804-094	1/-		24V	[A]				P&R 0,50 m
31-2804-174	1/-		24V	[B]				P&R 1,50 m
31-2814-004	1/-		24V	[C]				Schutzhaube protection cap P&R 0,50 m
31-2814-024	1/-		24V	[C]				Schutzhaube protection cap P&R 1,50 m
31-2864-004	1/-		24V	[D]				P&R 0,50 m
31-2864-034	1/-		24V	[D]				P&R 1,50 m



SIDEPOINT

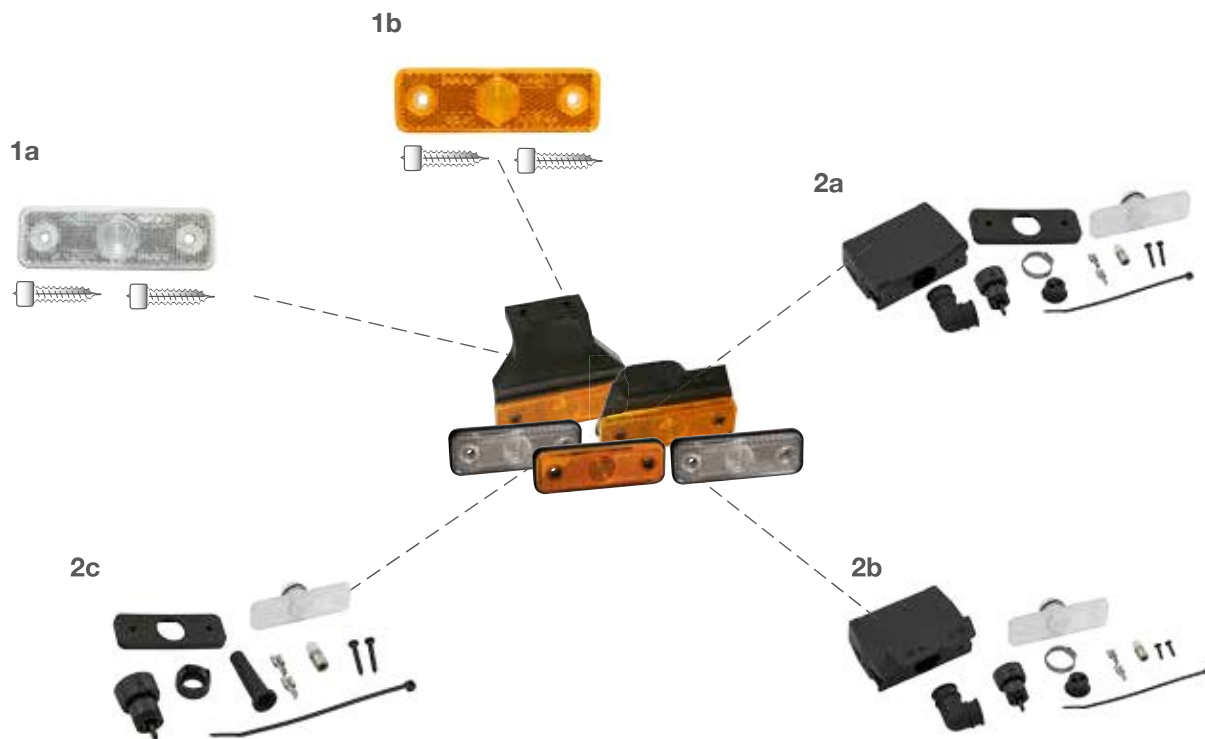

ZUBEHÖHR / ACCESSORIES



1 Lichtscheibe | lens

- (a) weiß mit Schrauben
white with screws 21-5000-024 
- (b) orange mit Schrauben
orange with screws 21-2800-004 

2 Ersatzleuchte weiß mit Schutzhaube | spare part lamp white with protection cap

- (a) mit 90° Anschluss ohne Haltewinkel
with 90° connector without bracket
..... 21-5000-004 
- (b) mit 90° Anschluss und 90° Haltewinkel
with 90° connector and 90° bracket
..... 21-5000-034 
- (c) mit geradem Anschluss ohne Haltewinkel
with straight connector without bracket
..... 21-5000-054 





SIDEPOINT

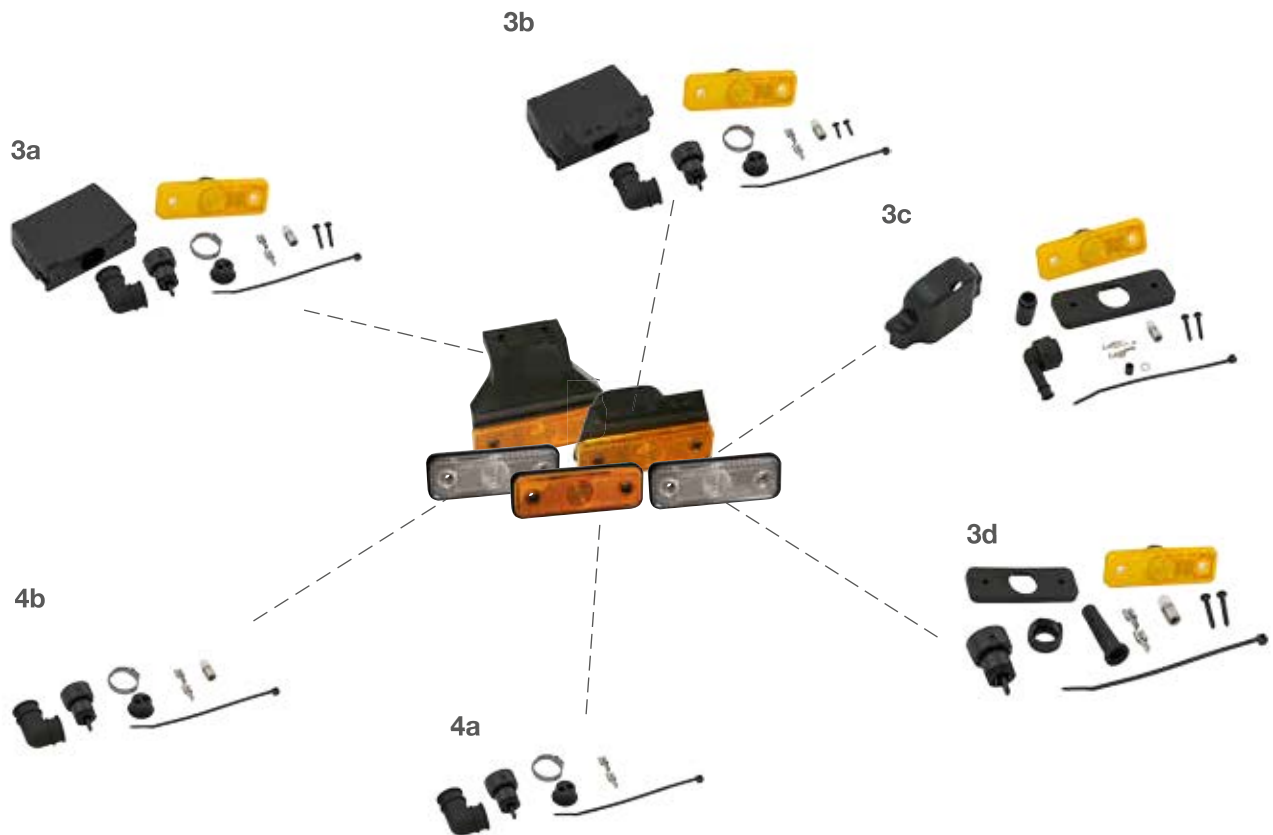

3 Ersatzleuchte orange mit Schutzhaube | spare part lamp orange with protection cap

- (a) mit 90° Anschluss ohne Haltewinkel
with 90° connector without bracket
..... 21-2801-004
- (b) mit 90° Anschluss und 90° Haltewinkel
with 90° connector and 90° bracket
..... 21-2800-014
- (c) mit 90° Anschluss und Schutzhaube
with 90° connector and with protection cap
..... 21-2801-064
- (d) mit geradem Anschluss ohne Haltewinkel
with straight connector without bracket
..... 21-2801-054

4 Anschluss | connector

- (a) ohne Glühlampe
without bulb..... 15-2128-524
- (b) mit Glühlampe
with bulb..... 15-2128-514





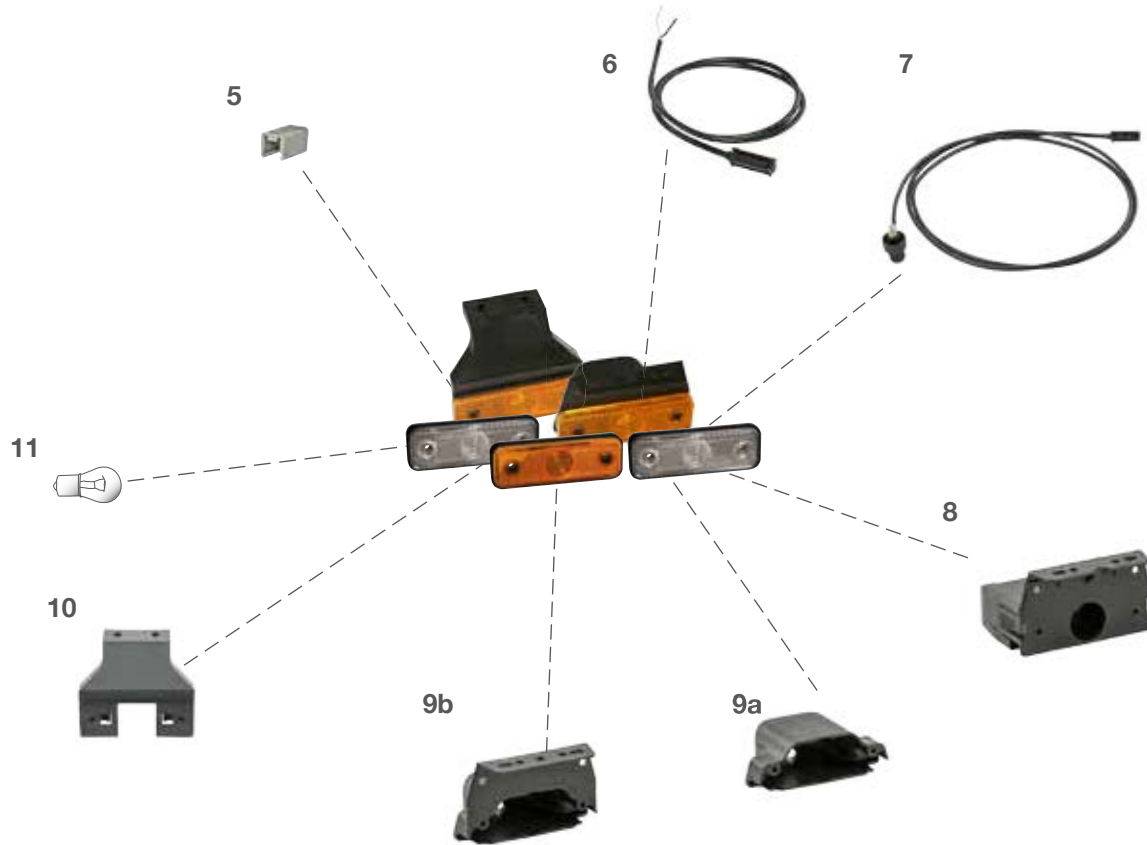

SIDEPOINT

ZUBEHÖHR / ACCESSORIES



5 Verschlusskappen für P&R Verbinder | caps for P&R connector
..... 15-5971-014 

6 Anschlusskabel P&R | connection cable P&R
0,50 m..... 68-5000-014 
1,50 m..... 68-5000-034 

7 Zuleitung P&R mit Anschluss und Gehäuse für Fassung | front connection P&R with connector and housing for lamp socket
2,00 m 31-2804-204 

8 Sockel mit Winkel und Schutzhaube | socket with bracket and protection cap
..... 15-2128-274 

9 Schutzhaube | protection cap
(a) ohne Haltewinkel
without bracket..... 15-2122-164 
(b) mit 90° Haltewinkel
with 90° bracket..... 15-2122-174 

10 Haltewinkel | bracket
schräg
sloping..... 15-2128-144 

11 Glühlampe | bulb
24V 4W 16-6304-027 









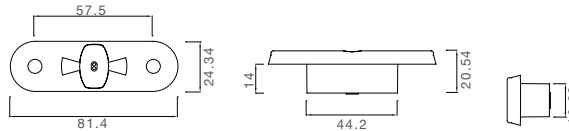















































































POSIPOINT II LED

ADR Zone 2 IP 6K9K



 Positionslight
Position Light

BEST. NR				ZUSATZ	ANSCHLUSS
PART NO				ADD ON	CONNECTOR
31-7100-004	1/-	LED	12V 24V	 	offenes Ende open end 5,00 m 
31-7100-014	1/-	LED	12V 24V	 	offenes Ende open end 3,50 m 
31-7100-034	1/-	LED	12V 24V	 	offenes Ende open end 1,50 m 
31-7100-054	1/-	LED	12V 24V	  MAN Version	2 pol. AFS lear    0,30 m 
31-7100-064	1/-	LED	12V 24V	 	offenes Ende open end 0,50 m 
31-7100-104	-/-	LED	12V 24V	 	offenes Ende open end 0,30 m 
31-7100-114	1/-	LED	12V 24V	  mit 7,50 m Wellrohr with 7,50 m corrugated pipe	offenes Ende open end 8,00 m 
31-7104-004	1/-	LED	12V 24V	 	P&R   0,50 m 
31-7104-014	1/-	LED	12V 24V	 	P&R   1,50 m 
31-7104-024	1/-	LED	12V 24V	 	P&R   3,50 m 
31-7104-034	1/-	LED	12V 24V	  mit Verschlusskappe with cap	P&R   5,00 m 
31-7104-054	-/-	LED	12V 24V	 	P&R   0,15 m 
31-7107-014	-/-	LED	12V 24V	 	2 pol. ASS2    1,30 m 
31-7110-004	-/-	LED	12V 24V	  mit 7,50 m Wellrohr with 7,50 m corrugated pipe	offenes Ende open end 8,00 m 
31-7204-014	1/-	LED	12V 24V	 	P&R   1,50 m 
31-7204-024	1/-	LED	12V 24V	 	P&R   3,50 m 
31-7204-044	1/-	LED	12V 24V	 	P&R   5,00 m 
31-7207-014	-/-	LED	12V 24V	 	2 pol. ASS3    0,50 m 
31-7210-004	1/-	LED	12V 24V	  mit 0,30 m Wellrohr with 0,30 m corrugated pipe	offenes Ende open end 0,80 m 





POSIPOINT II LED

ZUBEHÖHR / ACCESSORIES

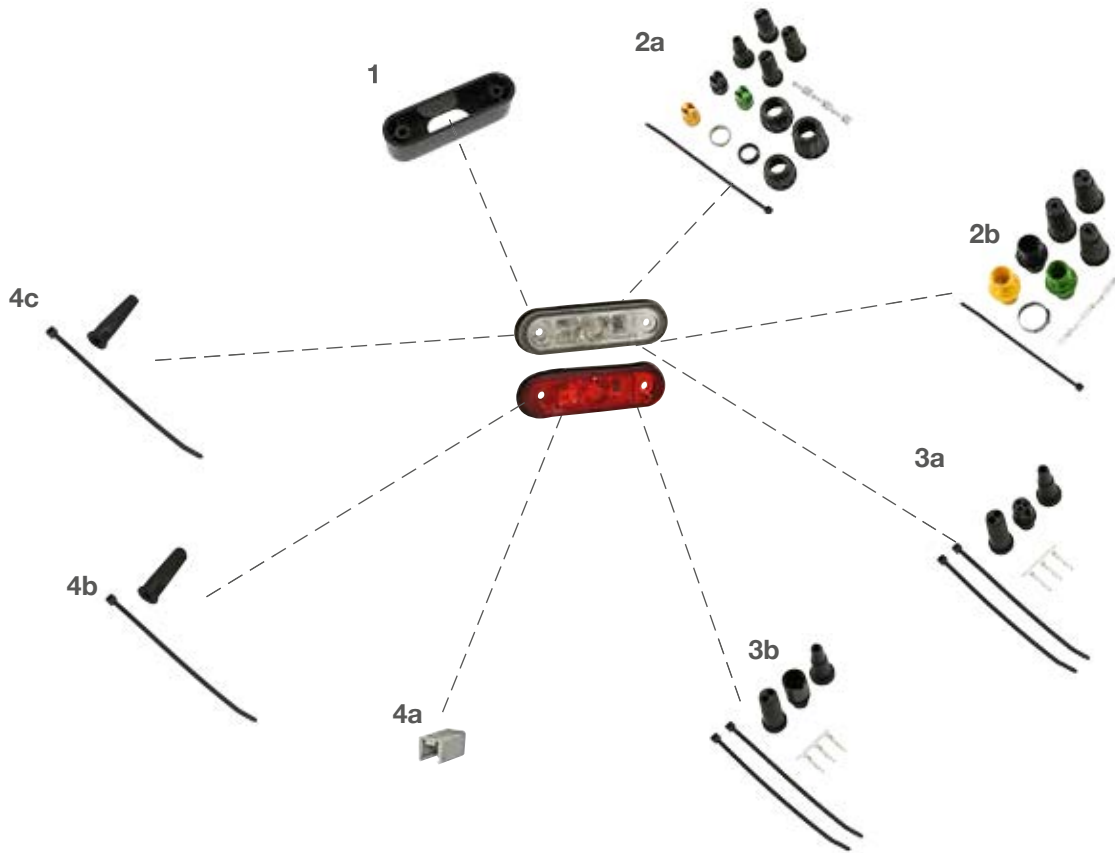

1 Gehäuse | housing
..... 15-5609-104

2 ASS1 & ASS2 Verbinder |
ASS1 & ASS2 connector
(a) 2 pol. weiblich
2 pin female 13-5626-401
(b) 2 pol. männlich
2 pin male 13-5625-991

3 ASS3 Verbinder | ASS3 connector
(a) 3 pol. weiblich
3 pin female 13-0322-281
(b) 3 pol. männlich
3 pin male 13-0332-281

4 für P&R Verbinder |
for P&R connector
(a) Verschlusskappen
caps 15-5971-014
(b) Endkappen rund
end caps round 15-5983-024
(c) Endkappen eckig
end caps square 15-5729-014





POSIPOINT I LED

ADR Zone 2 IP 6K9K

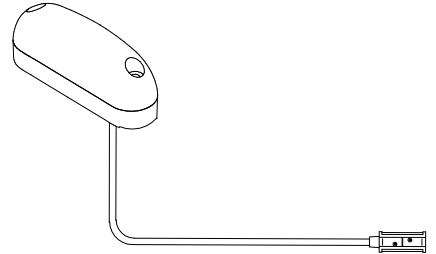
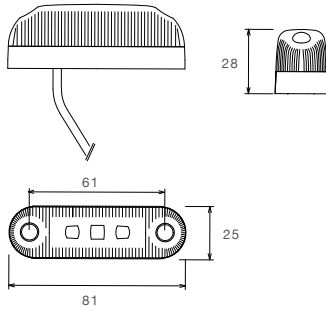

BEST. NR				ZUSATZ	ANSCHLUSS
PART NO				ADD ON	CONNECTOR
31-6004-074	1/-	LED	24V		P&R 0,50 m
31-6004-094	1/-	LED	24V		P&R 5,00 m
31-6204-084	1/-	LED	24V		P&R 0,50 m
31-6204-104	1/-	LED	24V		P&R 5,00 m



POSIPOINT I LED

ZUBEHÖHR / ACCESSORIES

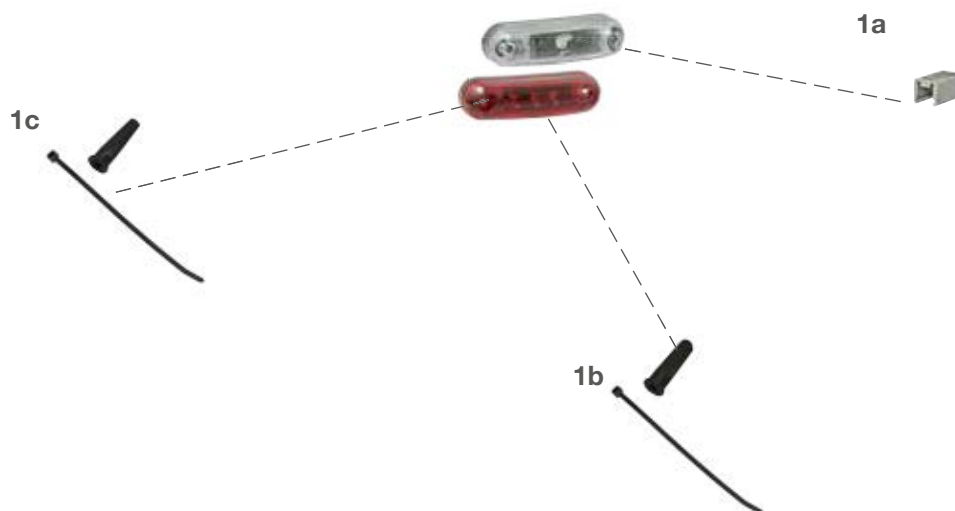

1 für P&R Verbinder I for P&R connector

- (a) Verschlusskappen
caps..... 15-5971-014
- (b) Endkappen rund
end caps round..... 15-5983-024
- (c) Endkappen eckig
end caps square..... 15-5729-014









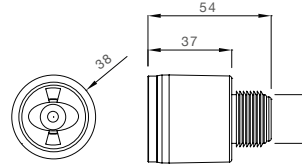
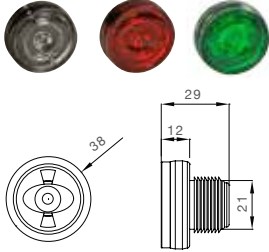























































MONOPOINT II LED

ADR Zone 2 IP 6K9K



 Positionslight
Position Light

BEST. NR				ZUSATZ	ANSCHLUSS	
PART NO				ADD ON	CONNECTOR	
31-6700-024	1/-	LED	12V 24V	 	offenes Ende open end	3,50 m 
31-6704-064	1/-	LED	12V 24V	 	P&R 	0,50 m 
31-6704-074	1/-	LED	12V 24V	 	P&R 	1,50 m 
31-6704-084	1/-	LED	12V 24V	 	P&R 	3,50 m 
31-6704-124	1/-	LED	12V 24V	 	P&R  	5,00 m 
31-6704-204	1/-	LED	12V 24V	 	P&R 	1,70 m 
31-6707-054	-/-	LED	12V 24V	 	3 pol. ASS3 3 pin ASS3	  1,50 m 
31-6700-044	1/-	LED	12V 24V	 	2 pol. MKR plus Lear 2 pin MKR plus Lear	  0,50 m 
31-6700-064	-/-	LED	12V 24V	 	2 pol. Superseal 2 pin Superseal	  0,25 m 
31-6700-014	1/-	LED	12V 24V	  + [A]	offenes Ende open end	3,70 m 
31-6700-034	1/-	LED	12V 24V	 	offenes Ende open end	3,50 m 
31-6704-094	1/-	LED	12V 24V	 	P&R 	0,50 m 
31-6704-104	1/-	LED	12V 24V	 	P&R 	1,50 m 
31-6704-114	1/-	LED	12V 24V	 	P&R 	3,50 m 



MONOPOINT II LED

ADR Zone 2 IP 6K9K

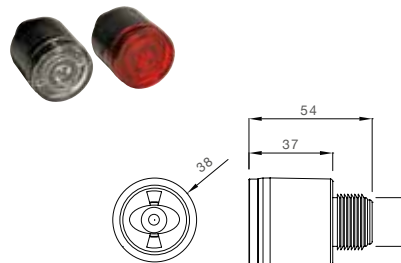
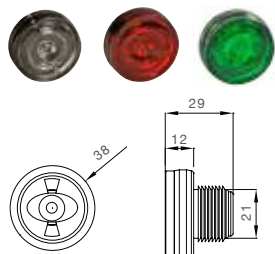

BEST. NR				ZUSATZ	ANSCHLUSS
PART NO				ADD ON	CONNECTOR
31-6800-014	1/-	LED	12V 24V		offenes Ende open end 3,50 m
31-6804-064	1/-	LED	12V 24V		P&R 3,50 m
31-6804-084	1/-	LED	12V 24V		P&R 0,50 m
31-6804-094	-/-	LED	12V 24V		P&R 5,00 m
31-6807-014	-/-	LED	12V 24V		3 pol. ASS3 3 pin ASS3 0,50 m
31-6804-074	1/-	LED	12V 24V		P&R 3,50 m
31-7400-004	-/-	LED	12V 24V		offenes Ende open end 3,50 m
31-7400-014	-/-	LED	12V 24V		P&R 3,50 m





MONOPOINT II LED

ZUBEHÖHR / ACCESSORIES

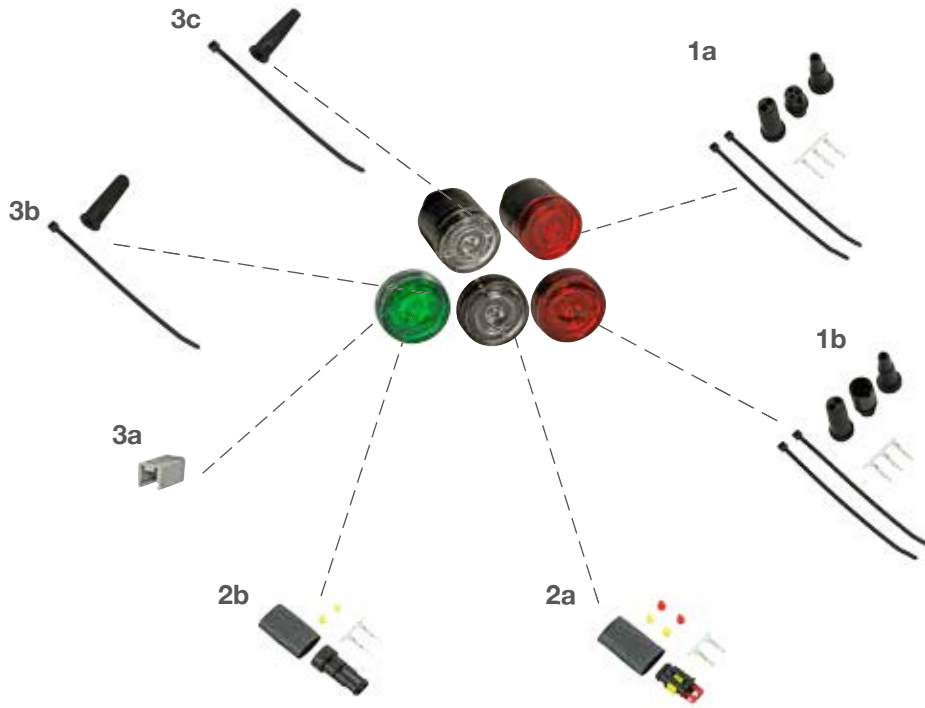

- 1 ASS3 Verbinder | ASS3 connector**
- (a) 3 pol. weiblich
3 pin female 13-0322-281
 - (b) 3 pol. männlich
3 pin male 13-0332-281
- 2 Superseal Verbinder | Superseal connector**
- (a) 2 pol. weiblich
2 pin female 15-7002-044
 - (b) 2 pol. männlich
2 pin male 15-7002-054

- 3 für P&R Verbinder | for P&R connector**
- (a) Verschlusskappen
caps 15-5971-014
 - (b) Endkappen rund
end caps round 15-5983-024
 - (c) Endkappen eckig
end caps square 15-5729-014







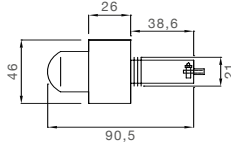



























MONOPOINT I LED

ADR Zone 2 IP 6K9K



 Positionslight
Position Light

BEST. NR				ZUSATZ	ANSCHLUSS
PART NO				ADD ON	CONNECTOR
31-6704-014	1/-	LED	12V 24V	 	P&R  0,50 m 
31-6704-054	1/-	LED	12V 24V	 	P&R  3,50 m 
31-6707-044	-/-	LED	12V 24V	 	3 pol. ASS3   3 pin ASS3  3,50 m 
31-6707-004	-/-	LED	12V 24V	 	2 pol. ASS2   2 pin ASS2  1,50 m 
31-6804-014	1/-	LED	12V 24V	 	P&R  0,50 m 
31-6807-024	-/-	LED	12V 24V	 	3 pol. ASS3   3 pin ASS3  0,50 m 



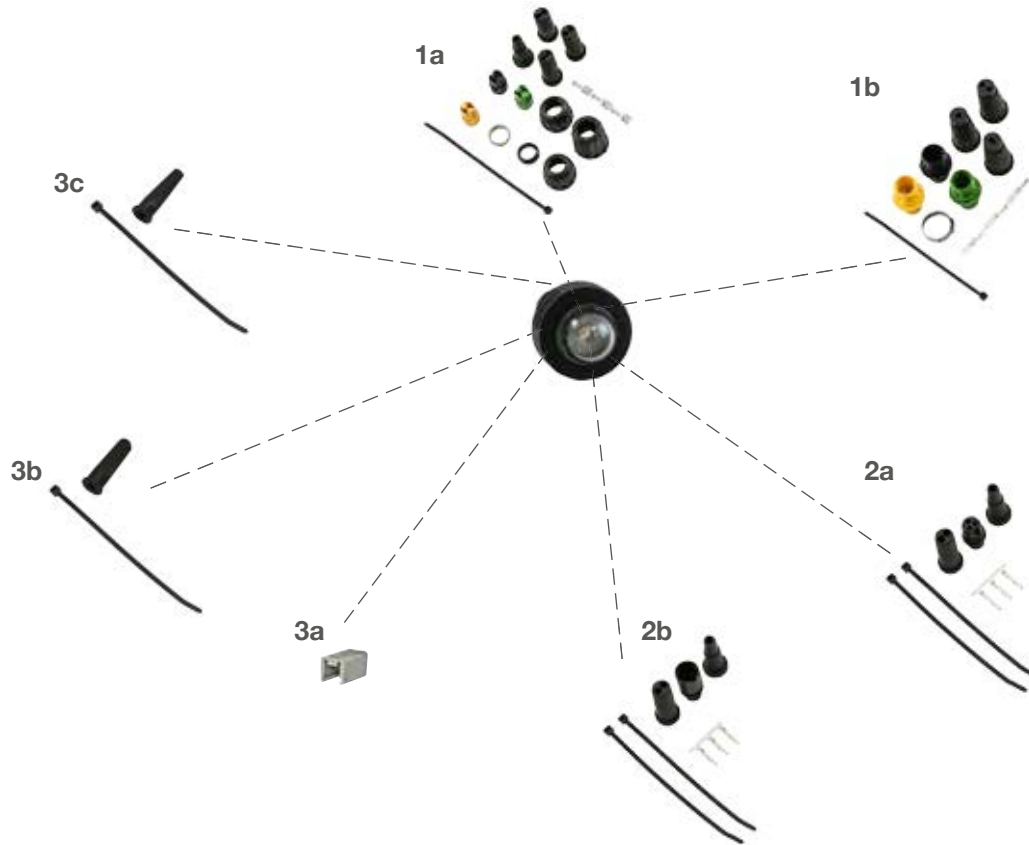

1 ASS1 & ASS2 Verbinder | ASS1 & ASS2 connector

- (a) 2 pol. weiblich
2 pin female 13-5626-401
- (b) 2 pol. männlich
2 pin male 13-5625-991

2 ASS3 Verbinder | ASS3 connector

- (a) 3 pol. weiblich
3 pin female 13-0322-281
- (b) 3 pol. männlich
3 pin male 13-0332-281

3 für P&R Verbinder | for P&R connector

- (a) Verschlusskappen
caps 15-5971-014
- (b) Endkappen rund
end caps round 15-5983-024
- (c) Endkappen eckig
end caps square 15-5729-014

FASSPÖCK[®]

S T E M S



KENNZEICHENLEUCHE

Um das Nummernschild bestmöglich ersichtlich zu machen, bietet das Sortiment von Aspöck Kennzeichenleuchten mit unterschiedlichen Designs an.

Durch die verschiedenen Anschlüsse kann die Leuchte einfach und schnell mit dem vorhandenen Kabelsystem verbunden werden.

NUMBER PLATE LAMP

In order to make the number plate as visible as possible, the Aspöck range offers registration plates in different designs.

Due to the different connections, the lamp can be easily and quickly connected with the existing cable system.

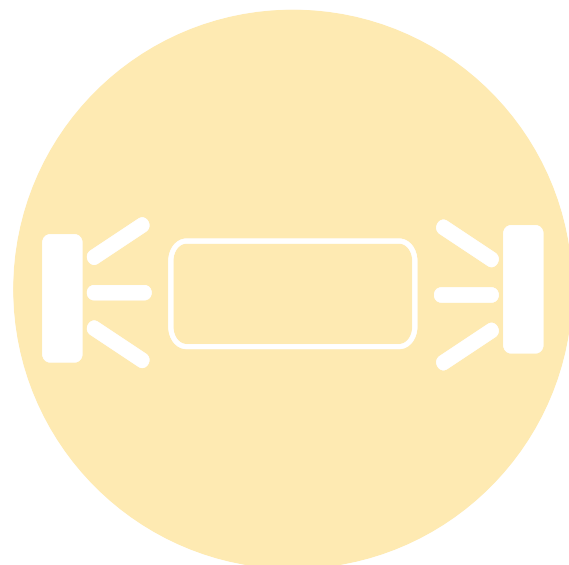



REGPOINT II LED









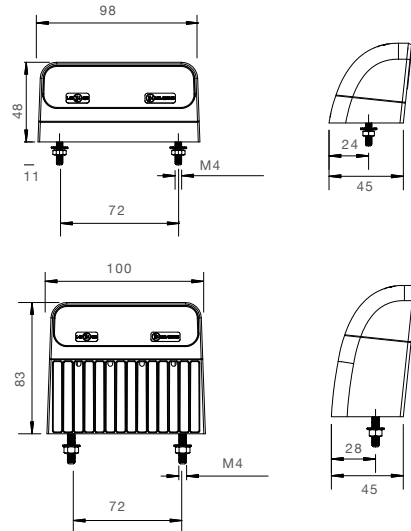















































ADR
Zone 2

IP 54



 Kennzeichenlicht
Number plate light



BEST. NR					ZUSATZ	ANSCHLUSS			
PART NO					ADD ON	CONNECTOR			
36-3804-004	1/-	LED	12V 24V			P&R		0,50 m	
36-3804-014	1/-	LED	12V 24V			P&R		2,00 m	
36-3806-004	1/-	LED	12V 24V			2 pol. ASS2 2 pin ASS2	  	0,50 m	
36-3805-004	1/-	LED	12V 24V			2 pol. ASS2 2 pin ASS2	  	2,00 m	
36-3807-004	1/-	LED	12V 24V			2 pol. Superseal 2 pin Superseal	  	0,50 m	
36-3810-004	1/-	LED	12V 24V			3 pol. ASS3 3 pin ASS3	  	0,50 m	
36-3864-004	1/-	LED	12V 24V		für Einzelbau for single mounting	P&R		0,50 m	
36-3864-014	1/-	LED	12V 24V		für Einzelbau for single mounting	P&R		2,00 m	
36-3867-014	1/-	LED	12V 24V		für Einzelbau for single mounting	2 pol. ASS2 2 pin ASS2	  	0,50 m	
36-3867-024	1/-	LED	12V 24V		für Einzelbau for single mounting	2 pol. ASS2 2 pin ASS2	  	2,00 m	
36-3865-004	1/-	LED	12V 24V		für Einzelbau for single mounting	3 pol. ASS3 3 pin ASS3	  	0,50 m	
36-3867-004	1/-	LED	12V 24V		für Einzelbau for single mounting	2 pol. Superseal 2 pin Superseal	  	0,50 m	



REGPOINT II LED

ZUBEHÖHR / ACCESSORIES

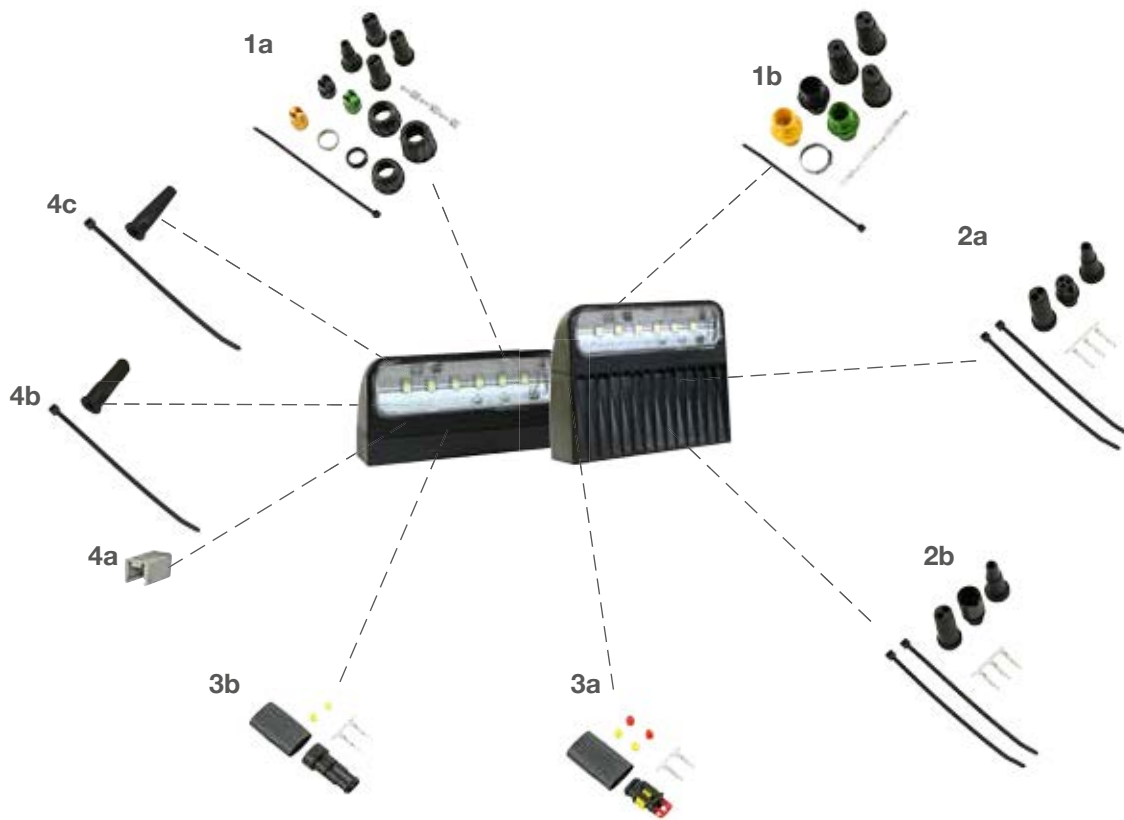

- 1 ASS1 & ASS2 Verbinder | ASS1 & ASS2 connector**
- (a) 2 pol. weiblich
2 pin female 13-5626-401
 - (b) 2 pol. männlich
2 pin male 13-5625-991
- 2 ASS3 Verbinder | ASS3 connector**
- (a) 3 pol. weiblich
3 pin female 13-0322-281
 - (b) 3 pol. männlich
3 pin male 13-0332-281
- 3 Superseal Verbinder | Superseal connector**
- (a) 2 pol. weiblich
2 pin female 15-7002-044
 - (b) 2 pol. männlich
2 pin male 15-7002-054

- 4 für P&R Verbinder | for P&R connector**
- (a) Verschlusskappen
caps 15-5971-014
 - (b) Endkappen rund
end caps round 15-5983-024
 - (c) Endkappen eckig
end caps square 15-5729-014



REGPOINT LED

ADR
Zone 2

IP 54

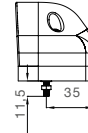
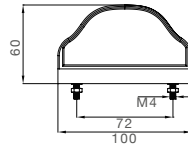
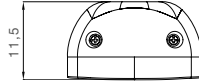

Kennzeichenlicht
Number plate light

BEST. NR				ZUSATZ	ANSCHLUSS	
PART NO				ADD ON	CONNECTOR	
36-3607-004	1/-	LED	24V		2 pol. ASS2 2 pin ASS2 ♀	0,50 m
36-3607-034	1/-	LED	24V		2 pol. ASS2 2 pin ASS2 ♀	0,80 m
36-3607-014	1/-	LED	24V		2 pol. ASS2 2 pin ASS2 ♀	1,00 m
36-3607-024	1/-	LED	24V		2 pol. ASS2 2 pin ASS2 ♀	3,50 m
36-3607-074	1/-	LED	24V		3 pol. ASS3 3 pin ASS3 ♀	0,50 m
36-3607-094	1/-	LED	24V		3 pol. ASS3 3 pin ASS3 ♀	1,00 m
36-3690-004	1/-	LED	24V		2 pol. AFK plus lear 2 pin AFK plus lear 	0,50 m
36-3690-034	1/-	LED	24V		2 pol. Deutsch 2 pin Deutsch ♂	0,17 m
36-3600-044	1/-	LED	24V		2 pol. Superseal 2 pin Superseal ♀	0,25 m
36-3690-014	1/-	LED	24V		2 pol. Superseal 2 pin Superseal ♂	3,50 m
36-3690-024	1/-	LED	24V		2 pol. Superseal 2 pin Superseal ♀	1,20 m
36-3690-044	1/-	LED	24V		2 pol. Superseal 2 pin Superseal ♂	0,15 m
36-3600-004	1/-	LED	24V		offenes Ende open end	0,50 m
36-3600-014	1/-	LED	24V		offenes Ende open end	1,00 m
36-3600-024	1/-	LED	24V		offenes Ende open end	3,50 m
36-3604-004	1/-	LED	24V		P&R 	0,50 m
36-3604-014	1/-	LED	24V		P&R 	1,00 m
36-3604-024	1/-	LED	24V		P&R 	1,50 m



REGPOINT LED

ZUBEHÖHR / ACCESSORIES

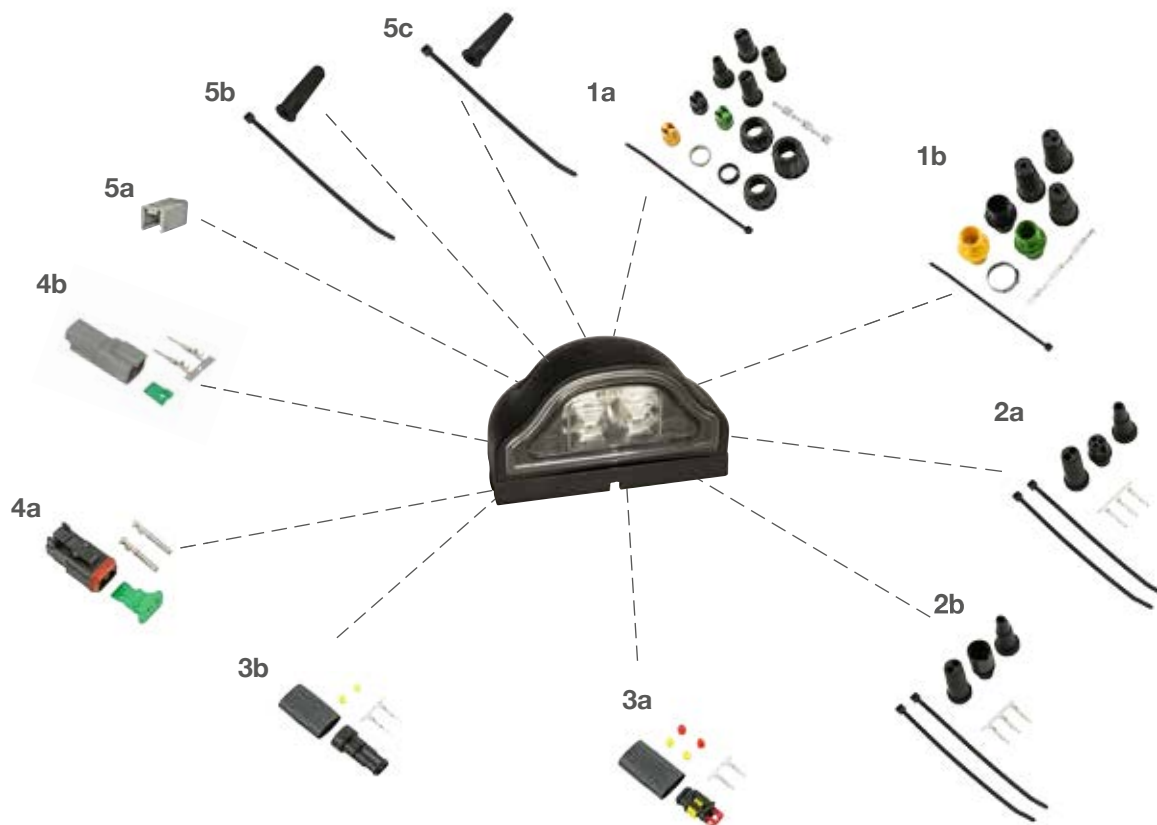

- 1 ASS1 & ASS2 Verbinder | ASS1 & ASS2 connector**
- (a) 2 pol. weiblich
2 pin female 13-5626-401
 - (b) 2 pol. männlich
2 pin male 13-5625-991
- 2 ASS3 Verbinder | ASS3 connector**
- (a) 3 pol. weiblich
3 pin female 13-0322-281
 - (b) 3 pol. männlich
3 pin male 13-0332-281
- 3 Superseal Verbinder | Superseal connector**
- (a) 2 pol. weiblich
2 pin female 15-7002-044
 - (b) 2 pol. männlich
2 pin male 15-7002-054

- 4 Deutsch Verbinder | Deutsch connector**
- (a) 2 pol. weiblich
2 pin female 15-7002-135
 - (b) 2 pol. männlich
2 pin male 15-7002-125
- 5 für P&R Verbinder | for P&R connector**
- (a) Verschlusskappen
caps 15-5971-014
 - (b) Endkappen rund
end caps round 15-5983-024
 - (c) Endkappen eckig
end caps square 15-5729-014









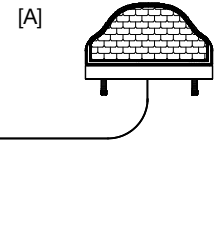
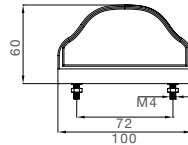
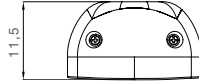









































REGPOINT

ADR
Zone 2

IP 54



 Kennzeichenlicht
Number plate light

BEST. NR				ZUSATZ	ANSCHLUSS	
PART NO				ADD ON	CONNECTOR	
36-3002-014	1/-		24V		offenes Ende open end	1,00 m 
36-3003-014	1/-		24V		offenes Ende open end	0,30 m 
36-3004-014	1/-		24V	M4x16	P&R 	0,50 m 
36-3004-024	1/-		24V		P&R 	1,00 m 
36-3004-034	1/-		24V		P&R 	1,50 m 
36-3004-044	1/-		24V		P&R 	2,00 m 
36-3004-054	1/-		24V		P&R 	3,50 m 
36-3007-284	1/-		24V		2 pol. ASS2 2 pin ASS2 	0,50 m 
36-3007-254	1/-		24V		2 pol. ASS2 2 pin ASS2 	1,20 m 
36-3007-084	1/-		24V		2 pol. ASS2 2 pin ASS2 	3,50 m 
36-3007-394	1/-		24V	M4x16	3 pol. ASS3 3 pin ASS3 	0,50 m 
36-3007-464	1/-		24V	M4x35	3 pol. ASS3 3 pin ASS3 	0,50 m 
36-3007-264	1/-		24V	[A]	2 pol. ASS2 2 pin ASS2  2 pol. ASS2 2 pin ASS2 	1,20 m  0,2 m 
36-3000-134	1/-		24V		2 pol. Superseal 2 pin Superseal 	1,20 m 
36-3007-574	1/-		24V		2 pol. ASS2 2 pin ASS2 	0,70 m 



REGPOINT

ZUBEHÖHR / ACCESSORIES

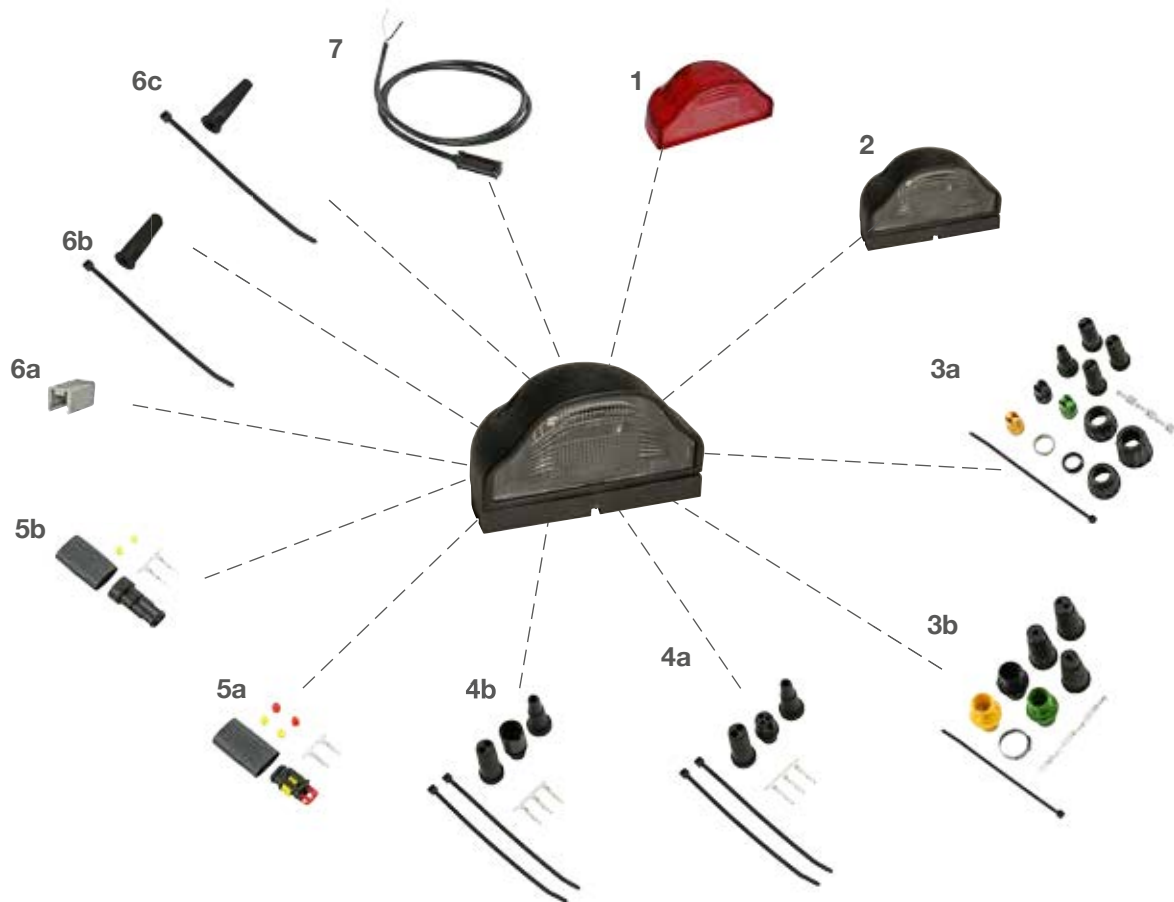

1 **Lichtscheibe | lens**
transparent rot
transparent red 18-8630-104

2 **Ersatzteilleuchte | spare part lamp**
weiß mit Schrauben
white with screws 26-3000-004

3 **ASS1 & ASS2 Verbinder | ASS1 & ASS2 connector**
(a) 2 pol. weiblich
2 pin female 13-5626-401
(b) 2 pol. männlich
2 pin male 13-5625-991

4 **ASS3 Verbinder | ASS3 connector**
(a) 3 pol. weiblich
3 pin female 13-0322-281
(b) 3 pol. männlich
3 pin male 13-0332-281

5 **Superseal Verbinder | Superseal connector**
(a) 2 pol. weiblich
2 pin female 15-7002-044
(b) 2 pol. männlich
2 pin male 15-7002-054

6 **für P&R Verbinder | for P&R connector**
(a) Verschlusskappen
caps 15-5971-014
(b) Endkappen rund
end caps round 15-5983-024
(c) Endkappen eckig
end caps square 15-5729-014

7 **Zuleitung P&R | front connection P&R**
0,5 m 68-5000-574
1,5 m 68-5000-604
2,0 m 68-5000-624
5,0 m 68-5000-634





REGPOINT rot
red

ADR
Zone 2

IP 54

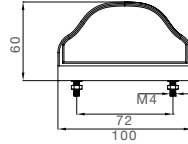
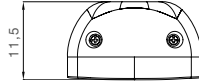

Kennzeichenlicht
Number plate light

BEST. NR PART NO				ZUSATZ ADD ON	ANSCHLUSS CONNECTOR
36-3004-184	1/-		24V		P&R 0,50 m
36-3004-084	1/-		24V		P&R 1,50 m



REGPOINT rot
red

ZUBEHÖHR / ACCESSORIES

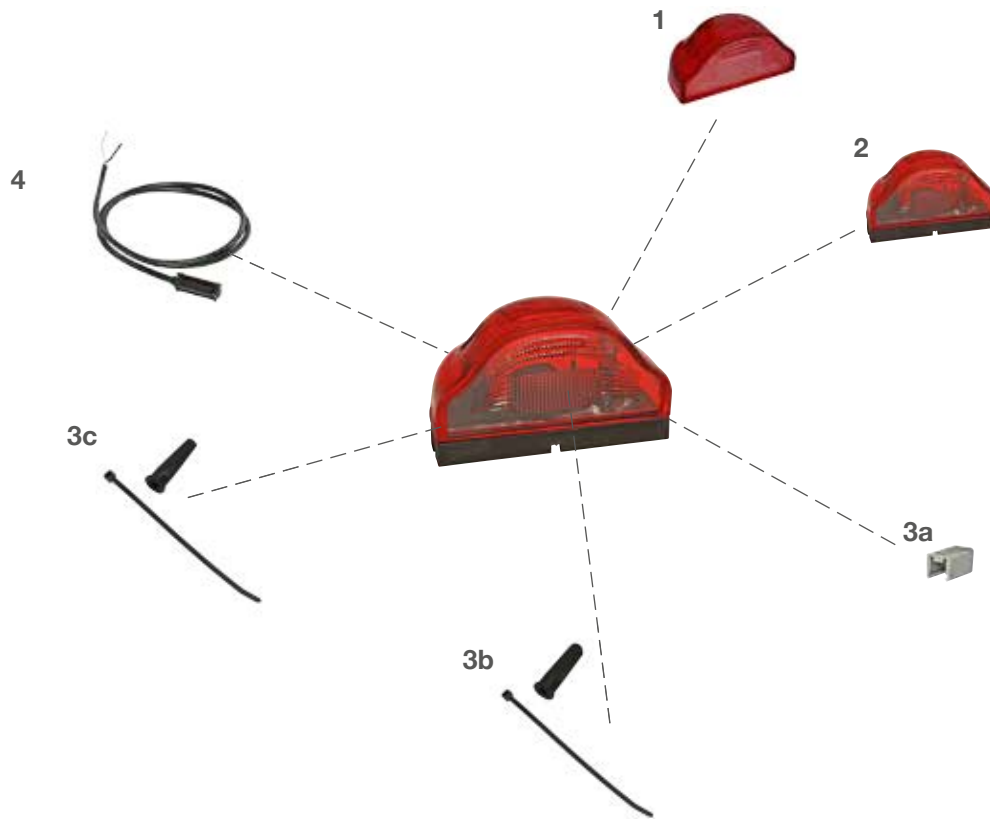

1 Lichtscheibe | lens
transparent rot
transparent red 18-8630-104

2 Ersatzteileuchte |
spare part lamp
rot mit Schrauben
red with screws..... 26-3010-004

3 für P&R Verbinder |
for P&R connector
(a) Verschlusskappen
caps..... 15-5971-014
(b) Endkappen rund
end caps round..... 15-5983-024
(c) Endkappen eckig
end caps square 15-5729-014

4 Zuleitung P&R | front connection P&R
0,5 m..... 68-5000-574
1,5 m..... 68-5000-604
2,0 m..... 68-5000-624
5,0 m..... 68-5000-634







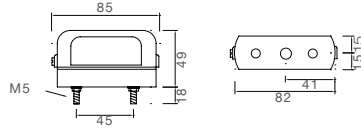











REGPOINT klein
small



 Kennzeichenlicht
Number plate light

BEST. NR				ZUSATZ ADD ON	ANSCHLUSS CONNECTOR
26-1200-004	1/-	-			Tülleneingang grommet  
36-1204-034	1/-		24V		P&R   0,50 m 
36-1207-004	1/-		24V		2 pol. ASS2  2 pin ASS2   1,50 m 



REGPOINT klein
small

ZUBEHÖHR / ACCESSORIES

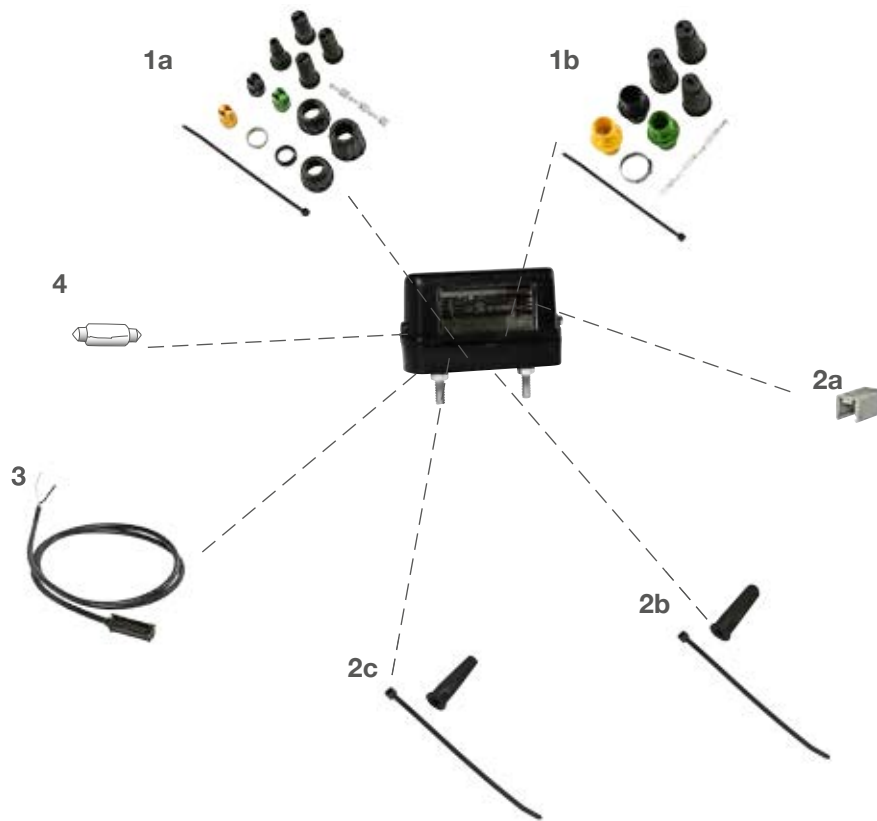

1 ASS1 & ASS2 Verbinder |
ASS1 & ASS2 connector

- (a) 2 pol. weiblich
2 pin female 13-5626-401
- (b) 2 pol. männlich
2 pin male 13-5625-991

2 für P&R Verbinder |
for P&R connector

- (a) Verschlusskappen
caps 15-5971-014
- (b) Endkappen rund
end caps round 15-5983-024
- (c) Endkappen eckig
end caps square 15-5729-014

3 Zuleitung P&R | front connection P&R
0,5 m 68-5000-574

4 Soffitte
24V 5W 16-6705-017

FISHPÖCK[®]

S T E M S



BREMSLEUCHE

Aspöck Bremsleuchten sind wahlweise als Einbau- oder Aufbauversionen erhältlich. Sie eignen sich ideal zum Austausch von bestehenden Bremsleuchten, zur Aufrüstung als LED oder auch zum ergänzenden Anbau.

STOP LAMP

Aspöck brake lights are available either as integrated or as mounted versions. They are ideal for the replacement of existing brake lights, as LED retrofits or also for supplementary attachment.





3. BREMSLEUCHE / 3rd STOP LIGHT

ADR Zone 2 IP6K9K

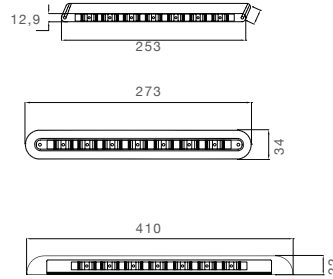



BEST. NR					ZUSATZ	ANSCHLUSS	
PART NO					ADD ON	CONNECTOR	
31-8900-024	1/-	LED	24V		Einbauversion lamp built in	offenes Ende open end	2,00 m
31-8900-044	1/-	LED	24V		Einbauversion lamp built-in	offenes Ende open end	6,00 m
31-8907-004	1/-	LED	24V		Einbauversion lamp built-in	2 pol. ASS2 2 pin ASS2	2,00 m
31-8907-014	1/-	LED	24V		inkl. Rahmen incl. housing	2 pol. ASS2 2 pin ASS2	2,00 m
31-8910-014	1/-	LED	24V		inkl. Rahmen incl. housing	offenes Ende open end	0,50 m
31-8910-024	1/-	LED	24V		inkl. Rahmen incl. housing	offenes Ende open end	2,00 m
31-9000-054	1/-	LED	24V		Aufbauversion lamp surface mount	offenes Ende open end	2,00 m
31-9007-014	1/-	LED	24V		Aufbauversion lamp surface mount	2 pol. ASS2 2 pin ASS2	2,00 m

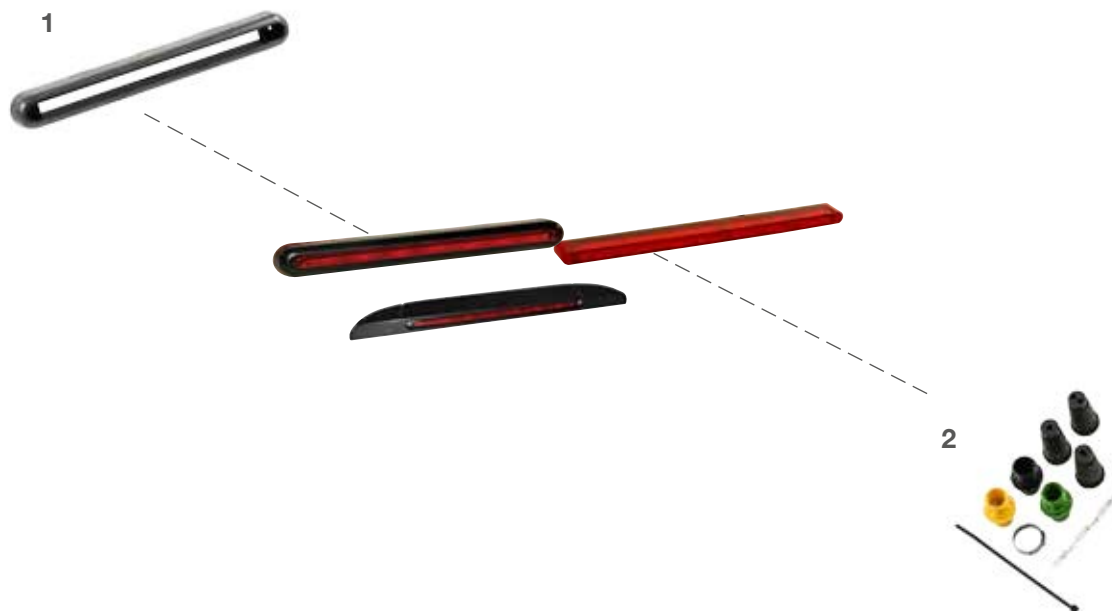

3. BREMSLEUCHE / 3rd STOP LIGHT

ZUBEHÖHR / ACCESSORIES



1 Rahmen | housing
..... 15-5203-004 

2 ASS1 & ASS2 Verbinder |
ASS1 & ASS2 connector
(a) 2 pol. weiblich
2 pin female 13-5626-401 
(b) 2 pol. männlich
2 pin male 13-5625-991 

FRÖCK®

E M S



ERSATZTEILE | SPARE PARTS

RÜCKFAHRLEUCHE ARBEITSSCHEINWERFER

Die Rückfahr- und Arbeitsscheinwerfer von Aspöck werden für maximale Beständigkeit unter extremen Bedingungen entwickelt. Langlebigkeit, hohe Lichtleistung und geringe Stromaufnahme sorgen dafür, dass der Arbeitsplatz auch bei schlechten Lichtverhältnissen und jedem Wetter optimal ausgeleuchtet ist.

REVERSE LAMP WORKING LAMP

The reverse lights and working lights by Aspöck have been developed for maximum resistance under extreme conditions. Longevity, high light output and low power consumption ensure that the workplace can be optimally illuminated even in poor light conditions and in any weather.





RÜCKFAHRSCHEINWERFER / REVERSE LAMP ARBEITSSCHEINWERFER / WORKING LAMP

ADR Zone 2 IP5K4K

21W

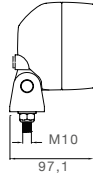
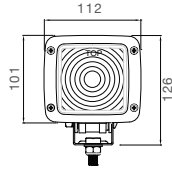

70W

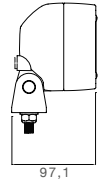
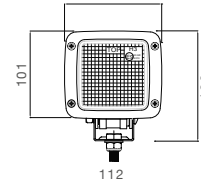

BEST. NR					ZUSATZ	ANSCHLUSS	
PART NO					ADD ON	CONNECTOR	
28-9100-001	1/-		24V		70W	Tülleneingang grommet	
38-9000-001	1/-		24V		21W	offenes Ende open end	2,50 m
38-9100-001	1/-		24V		70W	offenes Ende open end	2,50 m
38-9007-011	1/-		24V		21W	2 pol. ASS2 2 pin ASS2	2,50 m
38-9107-011	1/-		24V		70W	2 pol. ASS2 2 pin ASS2	2,50 m
38-9010-001	-/-		24V		21W	2 pol. Superseal 2 pin AMP	0,25 m
38-9100-081	-/-		24V		70W	2 pol. Deutsch 2 pin Deutsch	2,25 m



RÜCKFAHRSCHEINWERFER / REVERSE LAMP ARBEITSSCHEINWERFER / WORKING LAMP

ZUBEHÖR /
ACCESSORIES



1 ASS1 & ASS2 Verbinder | ASS1 & ASS2 connector

- (a) 2 pol. weiblich
2 pin female 13-5626-401
- (b) 2 pol. männlich
2 pin male 13-5625-991

2 Superseal Verbinder | Superseal connector

- (a) 2 pol. weiblich
2 pin female 15-7002-044
- (b) 2 pol. männlich
2 pin male 15-7002-054

3 Deutsch Verbinder | Deutsch connector

- (a) 2 pol. weiblich
2 pin female 15-7002-135
- (b) 2 pol. männlich
2 pin male 15-7002-125

4 Glühlampe | bulb

- 24V 70W H3 16-6456-001
- 24V 21W 16-6321-037



RÜCKFAHRSCHEINWERFER LED / REVERSE LAMP LED

ADR
Zone 2

IP56K

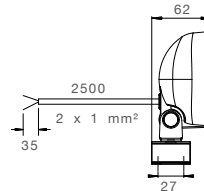
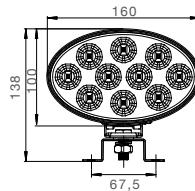

BEST. NR				ZUSATZ	ANSCHLUSS
PART NO				ADD ON	CONNECTOR
38-8200-001	1/-	LED	12V 24V	200 LUMEN -40°C bis +80°C	offenes Ende open end 2,50 m
38-8207-001	1/-	LED	12V 24V	200 LUMEN -40°C bis +80°C	2 pol. ASS2 2 pin ASS2 ♀ 2,50 m
38-8207-011	1/-	LED	12V 24V	200 LUMEN -40°C bis +80°C	2 pol. Superseal 2 pin Superseal ♂ 2,50 m

Rückfahrlicht
 Arbeitsscheinwerfer
 Reverse Lamp
 Working Lamp



RÜCKFAHRSCHEINWERFER LED / REVERSE LAMP LED

ZUBEHÖHR /
ACCESSORIES



1 ASS1 & ASS2 Verbinder | ASS1 & ASS2 connector

- (a) 2 pol. weiblich
2 pin female 13-5626-401
- (b) 2 pol. männlich
2 pin male 13-5625-991

2 Superseal Verbinder | Superseal connector

- (a) 2 pol. weiblich
2 pin female 15-7002-044
- (b) 2 pol. männlich
2 pin male 15-7002-054



WORKPOINT LED 3000

ADR Zone 2 IP 6K9K

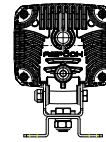
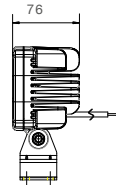
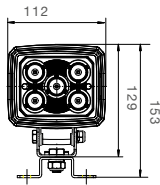

Arbeitsscheinwerfer
Working light

BEST. NR				ZUSATZ	ANSCHLUSS
PART NO				ADD ON	CONNECTOR
38-8221-001	1/-	LED	12V 24V	-40°C bis +80°C	offenes Ende open end 1,50 m
38-8221-101	1/-	LED	12V 24V	-40°C bis +80°C	offenes Ende open end 1,50 m
38-8227-001	1/-	LED	12V 24V	-40°C bis +80°C	2 pol. ASS2 2 pin ASS2 1,50 m
38-8227-101	1/-	LED	12V 24V	-40°C bis +80°C	2 pol. ASS2 2 pin ASS2 1,50 m

Rückleuchte
Arbeitsscheinwerfer
Reverse Lamp
Working Lamp



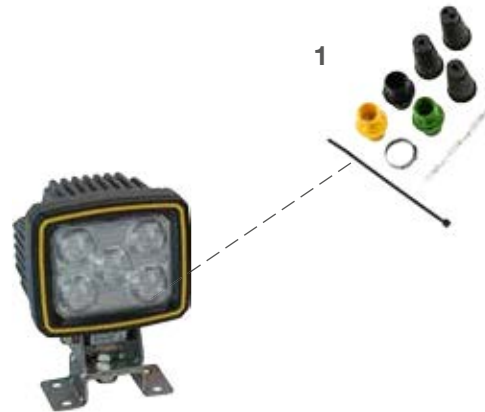

WORKPOINT LED 3000

ZUBEHÖHR / ACCESSORIES



1 ASS1 & ASS2 Verbinder | ASS1 & ASS2 connector

- (a) 2 pol. weiblich
2 pin female 13-5626-401 
- (b) 2 pol. männlich
2 pin male 13-5625-991 



WORKPOINT LED 1500

ADR Zone 2 IP 6K9K

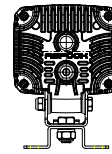
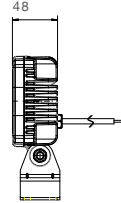
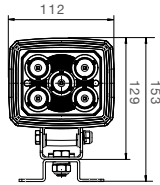

Rückfahrlicht Reverse light	Arbeitsscheinwerfer Working light
--------------------------------	--------------------------------------

BEST. NR				ZUSATZ	ANSCHLUSS
PART NO				ADD ON	CONNECTOR
38-8220-001	1/-	LED	12V 24V	1500 LUMEN 25W -40°C bis +80°C	offenes Ende open end 1,50 m
38-8220-011	1/-	LED	12V 24V	1500 LUMEN 25W -40°C bis +80°C	offenes Ende open end 7,50 m
38-8226-101	1/-	LED	12V 24V	1500 LUMEN 25W -40°C bis +80°C	2 pol. Superseal 2 pin Superseal 0,40 m
38-8226-111	1/-	LED	12V 24V	1500 LUMEN 25W -40°C bis +80°C	2 pol. Superseal 2 pin Superseal 1,50 m
38-8226-001	1/-	LED	12V 24V	1500 LUMEN 25W -40°C bis +80°C	2 pol. ASS2 2 pin ASS2 1,50 m
38-8227-021	1/-	LED	12V 24V	1500 LUMEN 25W -40°C bis +80°C	2 pol. ASS3 2 pin ASS3 0,50 m
38-8204-011	1/-	LED	12V 24V	1500 LUMEN 25W -40°C bis +80°C	P&R 0,50 m
38-8220-021	1/-	LED	12V 24V	1500 LUMEN 25W -40°C bis +80°C	2 pol. Deutsch 2 pin Deutsch 0,25 m

Rückfahrleuchte
Arbeitsscheinwerfer
Reverse Lamp
Working Lamp



WORKPOINT LED 1500

ZUBEHÖHR / accessories

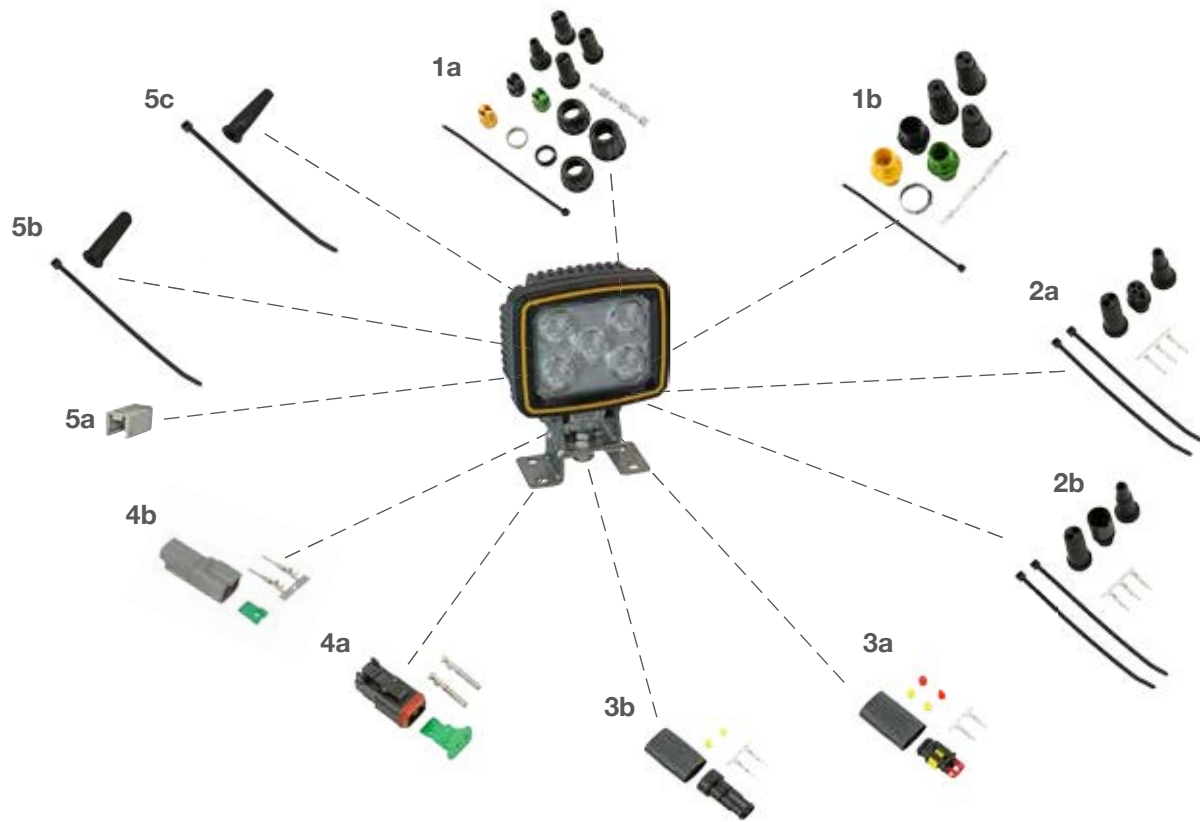

- 1 ASS1 & ASS2 Verbinder | ASS1 & ASS2 connector**
- (a) 2 pol. weiblich
2 pin female 13-5626-401
 - (b) 2 pol. männlich
2 pin male 13-5625-991
- 2 ASS3 Verbinder | ASS3 connector**
- (a) 3 pol. weiblich
3 pin female 13-0322-281
 - (b) 3 pol. männlich
3 pin male 13-0332-281
- 3 Superseal Verbinder | Superseal connector**
- (a) 2 pol. weiblich
2 pin female 15-7002-044
 - (b) 2 pol. männlich
2 pin male 15-7002-054

- 4 Deutsch Verbinder | Deutsch connector**
- (a) 2 pol. weiblich
2 pin female 15-7002-135
 - (b) 2 pol. männlich
2 pin male 15-7002-125
- 5 für P&R Verbinder | for P&R connector**
- (a) Verschlusskappen
caps 15-5971-014
 - (b) Endkappen rund
end caps round 15-5983-024
 - (c) Endkappen eckig
end caps square 15-5729-014









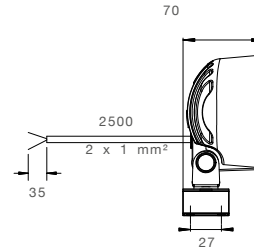
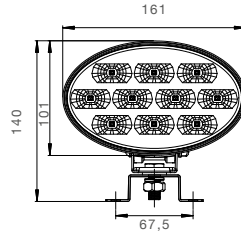









WORKPOINT LED 800

ADR
Zone 2

IP56K



 Arbeitsscheinwerfer
Working light

BEST. NR				ZUSATZ	ANSCHLUSS
PART NO				ADD ON	CONNECTOR
39-6800-011	1/-	LED	12V 24V	 	offenes Ende open end 2,50 m 
39-6801-001	1/-	LED	12V 24V	 	2 pol. Superseal  2 pin Superseal
39-6807-001	1/-	LED	12V 24V	 	2 pol. ASS2  2 pin ASS2 2,50 m 
39-6400-021	1/-	LED	12V 24V	 	2 pol. Deutsch  2 pin Deutsch 0,25 m 

Rückleuchte
Arbeitsscheinwerfer
Reverse Lamp
Working Lamp



WORKPOINT LED 800

ZUBEHÖHR / accessories

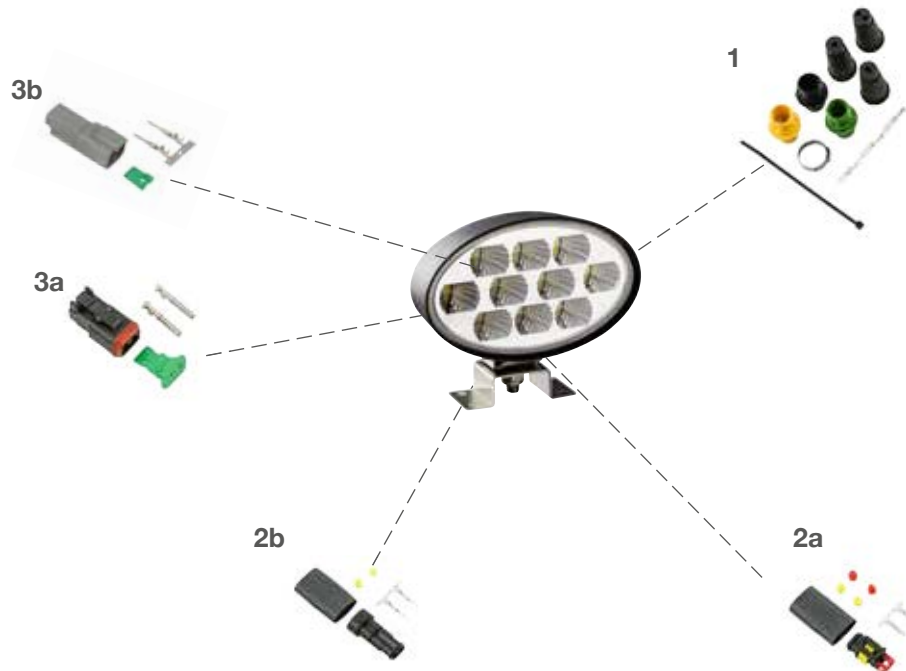

1 ASS1 & ASS2 Verbinder | ASS1 & ASS2 connector

- (a) 2 pol. weiblich
2 pin female 13-5626-401
- (b) 2 pol. männlich
2 pin male 13-5625-991

2 Superseal Verbinder | Superseal connector

- (a) 2 pol. weiblich
2 pin female 15-7002-044
- (b) 2 pol. männlich
2 pin male 15-7002-054

3 Deutsch Verbinder | Deutsch connector

- (a) 2 pol. weiblich
2 pin female 15-7002-135
- (b) 2 pol. männlich
2 pin male 15-7002-125





WORKPOINT LED 650

ADR Zone 2 IP56K

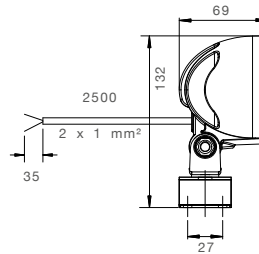
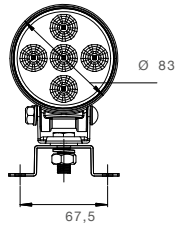

Arbeitsscheinwerfer
Working light

BEST. NR				ZUSATZ	ANSCHLUSS
PART NO				ADD ON	CONNECTOR
39-6400-011	1/-	LED	12V 24V	650 LUMEN	offenes Ende open end 2,50 m
39-6400-031	1/-	LED	12V 24V	650 LUMEN	2 pol. Superseal 2 pin Superseal 2,50 m
39-6407-001	1/-	LED	12V 24V	650 LUMEN	2 pol. ASS2 2 pin ASS2 2,50 m
39-6407-011	1/-	LED	12V 24V	650 LUMEN	2 pol. ASS2 2 pin ASS2 1,50 m
39-6400-041	1/-	LED	12V 24V	650 LUMEN	2 pol. Deutsch 2 pin Deutsch 0,30 m

Rückleuchte
Arbeitsscheinwerfer
Reverse Lamp
Working Lamp



WORKPOINT LED 650

ZUBEHÖHR / accessories

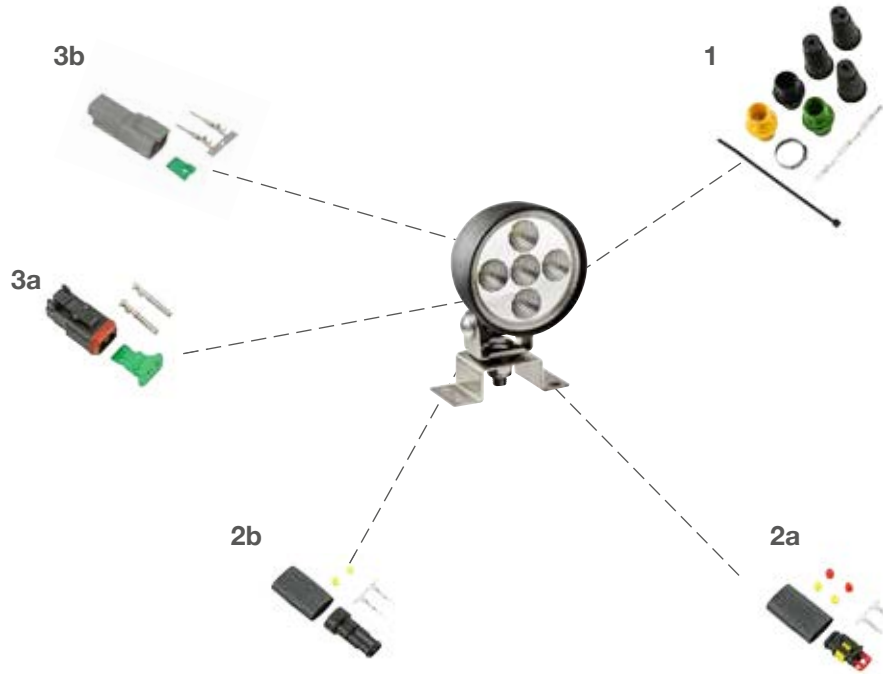

1 ASS1 & ASS2 Verbinder | ASS1 & ASS2 connector

- (a) 2 pol. weiblich
2 pin female 13-5626-401
- (b) 2 pol. männlich
2 pin male 13-5625-991

2 Superseal Verbinder | Superseal connector

- (a) 2 pol. weiblich
2 pin female 15-7002-044
- (b) 2 pol. männlich
2 pin male 15-7002-054

3 Deutsch Verbinder | Deutsch connector

- (a) 2 pol. weiblich
2 pin female 15-7002-135
- (b) 2 pol. männlich
2 pin male 15-7002-125

FISHPÖCK[®]

S T E M S

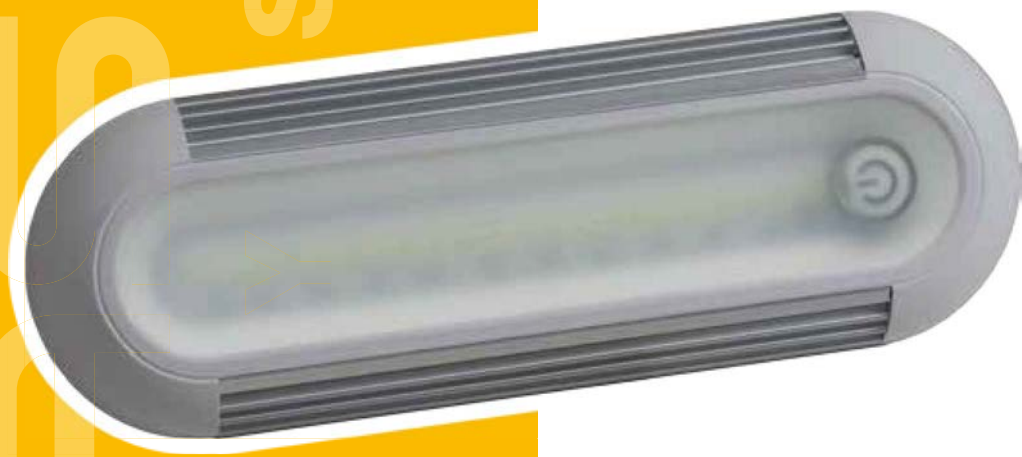

INNENLEUCHE

Um den Innenraum eines Fahrzeuges oder Anhängers auszuleuchten, befindet sich in der Produktpalette von Aspöck ein Sortiment an Leuchten, welche ideal für diesen Bereich geeignet sind. Verschiedene Formen und unterschiedliche Leuchtkraft runden das Angebot ab.

INTERIOR LAMP

In order to illuminate the interior of a vehicle or a trailer, Aspöck features an assortment of lamps in its product spectrum which are ideally suitable for this area. Different shapes and luminosities round off the range of offers.





INPOINT III LED lang, kurz,
long, short

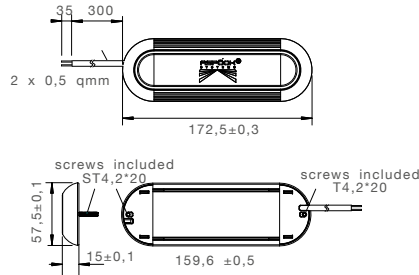
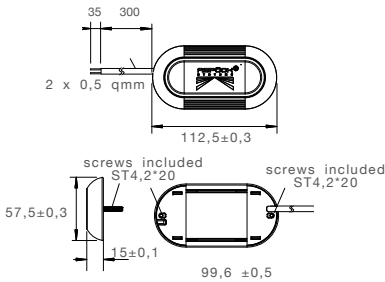

BEST. NR	PART NO	Box	LED	V	ZUSATZ ADD ON	ANSCHLUSS CONNECTOR
39-8900-001	1/-		12V 24V	lang long	-40°C bis +80°C 6000 +/- 500k IP6K9K 1400 LUMEN	offenes Ende open end 0,30 m
39-8900-051	1/-		12V 24V	lang, mit Bewegungssensor long, with motion sensor	-40°C bis +80°C 6000 +/- 500k IP67 1400 LUMEN	offenes Ende open end 0,30 m
39-8900-101	1/-		12V 24V	lang, mit Schalter long, with switch	-40°C bis +80°C 6000 +/- 500k IP6K9K 1400 LUMEN	offenes Ende open end 0,30 m
39-8900-151	1/-		12V 24V	kurz short	-40°C bis +80°C 6000 +/- 500k IP6K9K 700 LUMEN	offenes Ende open end 0,30 m
39-8900-201	1/-		12V 24V	kurz, mit Bewegungssensor short, with motion sensor	-40°C bis +80°C 6000 +/- 500k IP67 700 LUMEN	offenes Ende open end 0,30 m
39-8900-251	1/-		12V 24V	kurz, mit Schalter short, with switch	-40°C bis +80°C 6000 +/- 500k IP6K9K 700 LUMEN	offenes Ende open end 0,30 m

ZUBEHÖHR / ACCESSORIES

- 1** selbstklebende Gummiunterlage |
selfadhesive rubber
..... 15-5020-827





INPOINT III LED rund round

ADR
Zone 2

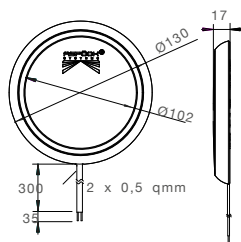

Innenlicht
Interior Light

BEST. NR					ZUSATZ			ANSCHLUSS
PART NO					ADD ON			CONNECTOR
39-8900-301	1/-	LED	12V 24V		rund round	-40°C bis +80°C 6000 +/- 500k		offenes Ende open end 0,30 m
39-8900-351	1/-	LED	12V 24V		rund, mit Bewegungssensor round, with motion sensor	-40°C bis +80°C 6000 +/- 500k		offenes Ende open end 0,30 m
39-8900-401	1/-	LED	12V 24V		rund, mit Schalter round, with switch	-40°C bis +80°C 6000 +/- 500k		offenes Ende open end 0,30 m



INNENLEUCHE LED RUND INTERIOR LAMP LED ROUND

IP 69

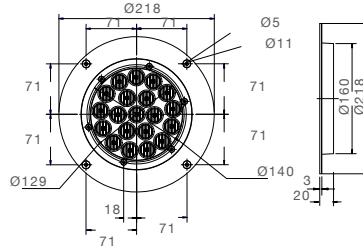

BEST. NR PART NO				ZUSATZ ADD ON	ANSCHLUSS CONNECTOR
29-8410-001	1/-	LED	12V 24V	140 LUMEN	offenes Ende open end 2 x 0,20 m
29-8410-101	1/-	LED	12V 24V	480 LUMEN	offenes Ende open end 2 x 0,20 m
39-8404-001	1/-	LED	12V 24V	140 LUMEN	P&R 0,25 m
39-8409-001	1/-	LED	12V 24V	140 LUMEN	offenes Ende open end 2 x 0,20 m

ZUBEHÖR / ACCESSORIES

1 für P&R Verbinder | for P&R connector

- (a) Verschlusskappen
caps..... 15-5971-014
- (b) Endkappen rund
end caps round..... 15-5983-024
- (c) Endkappen eckig
end caps square..... 15-5729-014

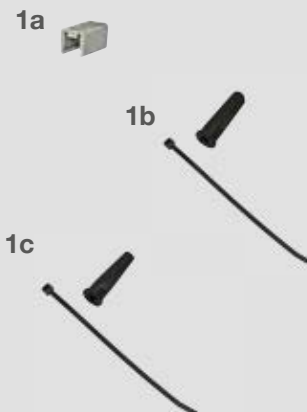



INNENLEUCHE LED INTERIOR LAMP LED

ZUBEHÖHR / ACCESSORIES

ADR Zone 2 IP 6K9K

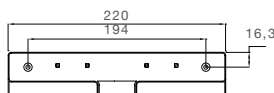

BEST. NR PART NO				ZUSATZ ADD ON	ANSCHLUSS CONNECTOR	
39-8700-011	-/-	LED	24V		offenes Ende open end	1,50 m
39-8704-001	-/-	LED	24V		P&R	0,25 m
39-8704-011	-/-	LED	24V		P&R	1,50 m
39-8707-001	-/-	LED	24V		3 pol. ASS3 3 pin ASS3	1,50 m

ZUBEHÖHR / ACCESSORIES

- 1 ASS3 Verbinder | ASS3 connector**
 - (a) 3 pol. weiblich
3 pin female 13-0322-281
 - (b) 3 pol. männlich
3 pin male 13-0332-281
- 2 für P&R Verbinder | for P&R connector**
 - (a) Verschlusskappen
caps 15-5971-014
 - (b) Endkappen rund
end caps round 15-5983-024
 - (c) Endkappen eckig
end caps square 15-5729-014

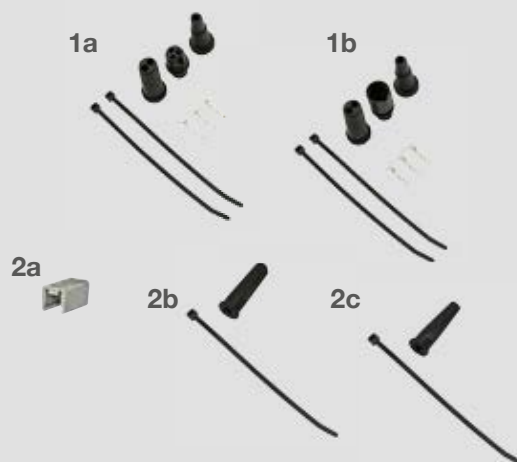

FASSPÖCK[®]

S Y S T E M S

ELEKTRONISCHES ZUBEHÖR VERBINDUNGSELEMENTE

Zum einfachen Vergleich sind auf den nächsten Seiten sämtliche Aspöck LED Kontrollgeräte aufgelistet, welche die Produktbezeichnung „LCG“ tragen. Auch eine Übersicht aller erhältlichen Aspöck Verbindungselemente ist hier zu finden.





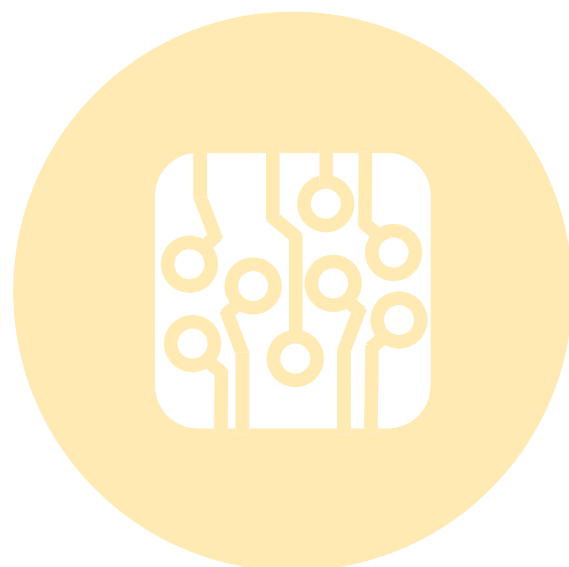





































ELECTRONIC ACCESORIES CONNECTION ELEMENTS

For simple comparison, all the Aspöck LED control devices bearing the product designation „LCG“ are listed on the following pages. You can also find an overview of all available Aspöck connection elements.



LCG

ÜBERSICHT / OVERVIEW

	LCG 1	LCG 2		LCG 3 UNIVERSAL	LCG UNIVERSAL 	LCG UNIVERSAL 	LCG EUROPOINT III
							
BEST. NR	75-0300-001	75-0310-001	75-0309-001	76-5132-011	75-0324-001	75-0314-001	25-7008-024
PART NO	75-0300-001	75-0310-001	75-0309-001	76-5132-011	75-0324-001	75-0314-001	25-7008-024
 V	24V	24V	24V	24V	24V	12-30V	12-30V
ANHÄNGERERKENNUNG AUSFALLÜBERWACHUNG							
TRAILER DETECTION FAILURE CONTROL							
SIMULATION GLÜHBIRNE	  	  	  	   			
POWER SIMULATION OF A BULB		 	 	 			
BENÖTIGTE MENGE PRO FAHRZEUG	2	1	1	1	1	2	2
QUANTITY REQUIRED PER VEHICLE	2	1	1	1	1	2	2
DAUERPLUS BENÖTIGT				●			
PERMANENT POWER REQUIRED				●			
KANN BEI FOLGENDEN LEUCHTEN VERWENDET WERDEN	bei allen Aspöck Heckleuchten ohne integriertem LCG	bei allen Aspöck Heckleuchten ohne integriertem LCG	bei allen Aspöck Heckleuchten mit integriertem LCG für Blinker	bei allen Aspöck Heckleuchten ohne integriertem LCG	bei allen Aspöck Heckleuchten mit integriertem LCG für Brems- licht	bei allen Aspöck Heckleuchten mit integriertem LCG für Blinker	
USABLE FOR THE FOLLOWING LAMPS	All Aspöck rearlamps without integrated LCG	All Aspöck rearlamps without integrated LCG	All Aspöck rearlamps with integrated LCG for direc- tion indicator	All Aspöck rearlamps without integrated LCG	All Aspöck rearlamps with integrated LCG for stop light	All Aspöck rearlamps with integrated LCG for direc- tion indicator	Europoint III

Allgemeiner Hinweis zum LCG!

In Hinsicht auf den geringen Leistungsverbrauch von LED Leuchten gegenüber Glühlampenleuchten kann es im Betrieb bei verschiedenen Zugfahrzeugen zu Problemen mit der Glühlampenausfallkontrolle kommen. Der geringe Leistungsverbrauch von LED Leuchten wird von vielen Zugfahrzeugen als ein Ausfall der Lichtfunktion gesehen und kann im Fahrzeuginneren zu einer visuellen Fehlermeldung führen.

Da die Kontrolle der Blinkerfunktion gesetzlich vorgeschrieben ist empfehlen wir die Aspöck LED Leuchten in Verbindung mit einem LED Control- Gerät „LCG“ zu betreiben.

Aspöck übernimmt keine Haftung für Funktionalität an allen Zugfahrzeugen und befreit dem Fahrer nicht von der Kontrolle der Funktionsfähigkeit der Beleuchtung.

Bei verschiedenen Zugfahrzeugen können zusätzliche nicht gesetzlich vorgeschriebene Lichtfunktionen kontrolliert werden die zu Fehlerdiagnosen im Fahrzeuginneren führen können. Diese zusätzliche Kontrolle ist eine Komfortfunktion des Fahrzeugs und befreit den Fahrer nicht von der visuellen Kontrolle der Lichtfunktion. (z.B.: Instrumententafel im Fahrerhaus zeigt einen Lampenausfall an, obwohl die Funktion gegeben ist) Eine Funktionsfähigkeit der Lampenausfallkontrolle ist ausschließlich durch den Fahrzeughersteller feststellbar!!!!

Der Betrieb der Leuchte mit Wechselspannung oder getakteter Gleichspannung ist nicht zulässig. Die einzelnen Funktionen der Leuchte dürfen nur mit einer fahrzeugseitigen Sicherung von max. 3A betrieben werden.

General advice to the LCG!

Led lighting draws less current than Incandescent lamps. This is known to cause problems with certain Vehicle Bulb failure Monitoring systems, across all manufacturers.

The low power consumption of led lamps can lead to a visual error message to the driver. As monitoring of the direction indicator is a mandatory requirement, we recommend Aspoeck Led lamps are always used in conjunction with our Led Control Gear „LCG“ Aspoeck cannot accept any liability for incompatibility of the „LCG“ with the non-mandatory functions, these are provided for driver convenience. With the variation of vehicle types available it is impossible for Aspoeck to verify every combination.

It is the Driver of the vehicles Legal responsibility to check all lighting is operating correctly. It must also be noted that the maximum current for each function is 3A. Please take care if connecting a Vehicle to an „AC source or pulsed DC“ as this will lead to component Failure.

No liability will be accepted for the use of „LCG“ with non-approved Vehicles or lamps. Aspoeck Accepts no other terms and installation of our products will be deemed as full acceptance of our Terms and conditions.

VERBINDER / CONNECTORS

ÜBERSICHT / OVERVIEW

ASS1 & ASS2

13-5626-401		 30	2 pol. weiblich 2 pin female
13-5625-991		 29	2 pol. männlich 2 pin male
13-5626-631		 41	7 pol. weiblich 7 pin female
13-5625-981		 38	7 pol. männlich 7 pin male

ASS3

13-0322-281		 18	3 pol. weiblich 3 pin female
13-0332-281		 18	3 pol. männlich 3 pin male
13-1722-001		 34	17 pol. weiblich 17 pin female
13-1732-001		 38	17 pol. männlich 17 pin male

Bajonett | bayonet

13-0246-004		 20	2 pol. weiblich 2 pin female
13-0236-004		 17	2 pol. männlich 2 pin male
13-0521-104		 27	5 pol. weiblich 5 pin female
13-0536-044		 24	5 pol. männlich 5 pin male
13-0828-034		 27	8 pol. weiblich 8 pin female
15-0821-524		 27	8 pol. weiblich 8 pin female
13-0838-054		 29	8 pol. männlich 8 pin male
13-1540-004		 38	15 pol. weiblich 15 pin female
13-1530-004		 34	15 pol. männlich 15 pin male



VERBINDER / CONNECTORS

ÜBERSICHT / OVERVIEW

AMP

15-7002-004			4 pol. weiblich 4 pin female
15-7002-014			4 pol. männlich 4 pin male
15-7002-024			7 pol. weiblich 7 pin female
15-7002-034			7 pol. männlich 7 pin male

Deutsch

15-7002-135			2 pol. weiblich 2 pin female
15-7002-125			2 pol. männlich 2 pin male
15-7002-155			4 pol. weiblich 4 pin female
15-7002-145			4 pol. männlich 4 pin male

Superseal

15-7002-044			2 pol. weiblich 2 pin female
15-7002-054			2 pol. männlich 2 pin male
15-7002-064			3 pol. weiblich 3 pin female
15-7002-074			3 pol. männlich 3 pin male
15-7002-084			4 pol. weiblich 4 pin female
15-7002-094			4 pol. männlich 4 pin male
15-7002-104			6 pol. weiblich 6 pin female
15-7002-114			6 pol. männlich 6 pin male

FASFPÖÖKX[®]

S Y S T E M S

ZUSÄTZLICHE INFORMATION

Eine Übersicht und Auflistung produktbezogener Informationen sowie die Legende der verwendeten Piktogramme sind auf den nächsten Seiten ersichtlich.

ADDITIONAL INFORMATION

An overview and list of product-related information and the key to the pictograms used can be found on the following pages.



E - NUMMERN ÜBERSICHT

Heckleuchten / Glühbirne

3 Kammerleuchte	E9_5520
Earpont I	E9_1057
Ecoflex	E9_1853
Ecopoint I	E9_5266
Ecopoint I ohne Dreieck	E9_5266
Ecopoint II	E9_1853
Ecopoint II ohne Dreieck	E9_6246
Eurofab	E9_1211
Europoint III	E9_6984 E9_6985
Europoint II	E9_5497 E13_1787
Europoint I	E9_5167 E2_7078

Heckleuchten / LED

3 Kammerleuchte LED	E9_6556 E9_1139 E4_23271 E9_5595 E9_1490 E4_13992 E4_4052
Braspoint 98	E9_11417 E9_11875 E9_11874 E9_11873 E9_11418 E9_11419
Braspoint 140	E9_11412 E9_11416 E9_11876 E9_11887
EcoLED	E9_1854
Ecopoint I LED	E9_5266
Ecopoint II LED	E9_11865 E24_1804
Ecopoint II LED ohne Dreieck	E9_11866
Europoint III LED	E9_11093 E9_11094
Europoint II LED	E9_5497
MiniLED II	E9_6535 E9_6532 E9_6530 E9_6531
MultiLED	E9_1599 E9_1600
MultiLED II	E24_6110
Multipoint LED	E9_5186
Multipoint V LED	E9_5946
Linepoint I	E24_0145 E24_6109
Linepoint II	E9_11442 E9_11443

Positionsleuchte / Glühbirne

Flexipoint I rot	E9_5332
Flexipoint I weiß	E9_5332
Monopoint	E4_7740
Sidepoint weiß	E13_0484 E13_9592

Positionsleuchte / LED

Flatpoint I weiß LED	E24_6094
Flatpoint II rot LED	E9_5499
Flatpoint II weiß LED	E9_5499
Monopoint II rot LED	E9_5594
Monopoint II weiß LED	E9_5594
Posipoint II weiß LED	E9_5593
Posipoint II rot LED	E9_5593
Unipoint I rot LED	E9_5409
Unipoint I weiß LED	E9_5409

Seitenmarkierungsleuchte / Glühbirne

Sidepoint	E13_9592
-----------	----------

Seitenmarkierungsleuchte / LED

Flatpoint I LED	E24_6094
Flatpoint II LED	E9_5499
Unipoint I LED	E9_5409

Umrissleuchte / Glühbirne

Flexipoint I rot / weiß	E9_5532
Superpoint I	E13_0339 E13_2317
Superpoint II	E9_5315

Umrissleuchte / LED

Superpoint III LED	E9_1469
Superpoint IV LED	E9_6878

Kennzeichenleuchte / Glühbirne

Regpoint	E9_4127 E9_4135
Regpoint rot	E9_4059 E9_4127
Regpoint small	E20_9944

Kennzeichenleuchte / LED

Kennzeichenhalter inkl. 2 x KZL LED	E9_1558
Regpoint LED	E9_4133
Regpoint II LED	E4_4352

3. Bremsleuchte

3. Bremsleuchte	E9_4075
3. Bremsleuchten LED mit KZ-Halter	E9_4075

Arbeits- Rückfahrcheinwerfer

Arbeitsscheinwerfer / Rückfahrcheinwerfer	E9_4013 E9_1014
Rückfahrcheinwerfer LED oval	E9_6989
Workpoint LED 650	E13_12435
Workpoint LED 800	E13_12438
Workpoint LED 1500	E9_1228
Workpoint LED 3000	E9_1393

Innenleuchte

Innenleuchte LED rund	E24_0976
Inpoint III LED ohne Schalter	E9_1439 E9_1440
Inpoint III LED mit Schalter	E9_1439 E9_1440
Inpoint III LED mit Bewegungssensor	E9_1439 E9_1440
LED-Innenleuchte	E24_0976

APPROVAL NUMBER OVERVIEW

ZUBEHÖHR / ACCESSORIES

Rear lamps / bulb	
3 chamber lamp	E9_5520
Earpont I	E9_1057
Ecoflex	E9_1853
Ecopoint I	E9_5266
Ecopoint I without triangle	E9_5266
Ecopoint II	E9_1853
Ecopoint II without triangle	E9_6246
Eurofab	E9_1211
Europoint III	E9_6984 E9_6985
Europoint II	E9_5497 E13_1787
Europoint I	E9_5167 E2_7078

Rear lamps / LED	
3 chamber lamp LED	E9_6556 E9_1139 E4_23271 E9_5595 E9_1490 E4_13992 E4_4052
Braspoint 98 horizontal vertical	E9_11417 E9_11875 E9_11874 E9_11873 E9_11418 E9_11419
Braspoint 140	E9_11412 E9_11416 E9_11876 E9_11887
EcoLED	E9_1854
Ecopoint I LED	E9_5266
Ecopoint II LED	E9_11865 E24_1804
Ecopoint II LED without triangle	E9_11866
Europoint III LED	E9_11093 E9_11094
Europoint II LED	E9_5497
MiniLED II	E9_6535 E9_6532 E9_6530 E9_6531
MultiLED	E9_1599 E9_1600
MultiLED II	E24_6110
Multipoint LED	E9_5186
Multipoint V LED	E9_5946
Linepoint I	E24_0145 E24_6109
Linepoint II	E9_11442 E9_11443

Position lamps / bulb	
Flexipoint I red	E9_5332
Flexipoint I white	E9_5332
Monopoint	E4_7740
Sidepoint white	E13_0484 E13_9592

Position lamps / LED	
Flatpoint I white LED	E24_6094
Flatpoint II red LED	E9_5499
Flatpoint II white LED	E9_5499
Monopoint II red LED	E9_5594
Monopoint II white LED	E9_5594
Posipoint II white LED	E9_5593
Posipoint II red LED	E9_5593
Unipoint I red LED	E9_5409
Unipoint I white LED	E9_5409

Side marker lamps / bulb	
Sidepoint	E13_9592

Side marker lamps / LED	
Flatpoint I LED	E24_6094
Flatpoint II LED	E9_5499
Unipoint I LED	E9_5409

End outline marker lamps / bulb	
Flexipoint I red / white	E9_5532
Superpoint I	E13_0339 E13_2317
Superpoint II	E9_5315

End outline marker lamps / LED	
Superpoint III LED	E9_1469
Superpoint IV LED	E9_6878

Number plate lamps / LED	
Regpoint	E9_4127 E9_4135
Regpoint red	E9_4059 E9_4127
Regpoint small	E20_9944

Number plate lamps / LED	
Number plate pad include 2 x NPL LED	E9_1558
Regpoint LED	E9_4133
Regpoint II LED	E4_4352

Additional lamps	
3rd stop lamp	E9_4075
3rd stop lamp „LED“ with Registration Plate	E9_4075

Working-revers lamp	
Reverse-working lamp	E9_4013 E9_1014
Reversing lamp LED oval	E9_6989
Workpoint LED 650	E13_12435
Workpoint LED 800	E13_12438
Workpoint LED 1500	E9_1228
Workpoint LED 3000	E9_1393

Interior lamps	
Interior Lamp LED round	E24_0976
Inpoint III LED without switch	E9_1439 E9_1440
Inpoint III LED with switch	E9_1439 E9_1440
Inpoint III LED with motion sensor	E9_1439 E9_1440
LED-Interior Lamp	E24_0976

ARTIKELNUMMERN / PART NUMBERS

ARTIKEL NR PART NO	SEITE PAGE	ARTIKEL NR PART NO	SEITE PAGE	ARTIKEL NR PART NO	SEITE PAGE	ARTIKEL NR PART NO	SEITE PAGE	ARTIKEL NR PART NO	SEITE PAGE	ARTIKEL NR PART NO	SEITE PAGE
11-2128-194	105	13-0322-281	119	13-5625-981	57	13-5626-631	55	15-5609-104	119	15-5983-024	153
12-1522-004	34	13-0322-281	124	13-5625-981	61	13-5626-631	57	15-5609-104	119	15-5983-024	162
12-1522-004	38	13-0322-281	127	13-5625-981	68	13-5626-631	61	15-5623-304	13	15-5983-024	163
12-1522-014	34	13-0322-281	131	13-5625-981	71	13-5626-631	68	15-5623-304	19	15-7002-004	68
12-1522-014	38	13-0322-281	133	13-5625-981	76	13-5626-631	71	15-5623-304	23	15-7002-004	71
12-1522-024	34	13-0322-281	137	13-5625-981	81	13-5626-631	76	15-5623-304	29	15-7002-004	169
12-1522-024	38	13-0322-281	153	13-5625-981	168	13-5626-631	81	15-5623-304	53	15-7002-014	68
12-1522-034	34	13-0322-281	163	13-5625-991	76	13-5626-631	168	15-5624-014	111	15-7002-014	71
12-1522-034	38	13-0322-281	168	13-5625-991	81	14-0418-304	100	15-5624-024	111	15-7002-014	169
12-1522-144	28	13-0332-281	61	13-5625-991	87	14-4596-004	112	15-5729-014	85	15-7002-024	13
12-1522-154	28	13-0332-281	63	13-5625-991	91	15-0821-524	45	15-5729-014	87	15-7002-024	19
12-1526-004	34	13-0332-281	65	13-5625-991	104	15-0821-524	51	15-5729-014	91	15-7002-024	29
12-1526-004	38	13-0332-281	91	13-5625-991	111	15-0821-524	57	15-5729-014	95	15-7002-024	43
12-1526-014	34	13-0332-281	95	13-5625-991	119	15-0821-524	68	15-5729-014	100	15-7002-024	51
12-1526-014	38	13-0332-281	100	13-5625-991	119	15-0821-524	71	15-5729-014	105	15-7002-024	53
12-1526-024	34	13-0332-281	105	13-5625-991	127	15-0821-524	76	15-5729-014	111	15-7002-024	55
12-1526-024	38	13-0332-281	111	13-5625-991	131	15-0821-524	168	15-5729-014	119	15-7002-024	68
12-1526-034	34	13-0332-281	119	13-5625-991	133	15-2122-104	104	15-5729-014	121	15-7002-024	71
12-1526-034	38	13-0332-281	119	13-5625-991	137	15-2122-124	104	15-5729-014	124	15-7002-024	76
12-1526-144	28	13-0332-281	124	13-5625-991	139	15-2122-164	104	15-5729-014	127	15-7002-024	81
12-1526-154	28	13-0332-281	127	13-5625-991	143	15-2122-164	117	15-5729-014	131	15-7002-024	169
12-1526-164	28	13-0332-281	131	13-5625-991	147	15-2122-174	104	15-5729-014	133	15-7002-034	51
12-1527-004	57	13-0332-281	133	13-5625-991	149	15-2122-174	117	15-5729-014	135	15-7002-034	55
12-1528-001	28	13-0332-281	137	13-5625-991	151	15-2128-094	104	15-5729-014	137	15-7002-034	68
12-1528-001	41	13-0332-281	153	13-5625-991	153	15-2128-144	105	15-5729-014	139	15-7002-034	71
12-1529-001	28	13-0332-281	168	13-5625-991	155	15-2128-217	101	15-5729-014	153	15-7002-034	76
12-1529-001	41	13-0521-104	45	13-5625-991	157	15-2128-274	105	15-5729-014	162	15-7002-034	81
12-1530-004	55	13-0521-104	51	13-5625-991	168	15-2128-285	112	15-5729-014	163	15-7002-034	169
12-1560-001	18	13-0521-104	59	13-5626-401	13	15-2128-514	117	15-5971-014	131	15-7002-044	13
12-1560-011	18	13-0521-104	68	13-5626-401	19	15-2128-524	116	15-5971-014	162	15-7002-044	19
12-1560-021	18	13-0521-104	71	13-5626-401	23	15-2128-544	94	15-5971-014	85	15-7002-044	29
12-1560-031	18	13-0521-104	76	13-5626-401	29	15-5111-004	100	15-5971-014	87	15-7002-044	65
12-1560-141	18	13-0521-104	168	13-5626-401	53	15-5111-404	65	15-5971-014	92	15-7002-044	76
12-1570-001	12	13-0536-044	45	13-5626-401	76	15-5203-004	143	15-5971-014	95	15-7002-044	81
12-1570-101	12	13-0536-044	51	13-5626-401	81	15-5270-004	13	15-5971-014	100	15-7002-044	87
12-1570-204	12	13-0536-044	68	13-5626-401	87	15-5270-004	18	15-5971-014	105	15-7002-044	91
12-1570-214	12	13-0536-044	71	13-5626-401	91	15-5270-004	21	15-5971-014	111	15-7002-044	95
12-1570-224	12	13-0536-044	76	13-5626-401	94	15-5276-004	13	15-5971-014	117	15-7002-044	131
12-1570-234	12	13-0536-044	168	13-5626-401	104	15-5276-004	18	15-5971-014	119	15-7002-044	133
12-1574-204	12	13-0828-034	45	13-5626-401	111	15-5276-004	18	15-5971-014	119	15-7002-044	147
12-1574-214	12	13-0828-034	51	13-5626-401	119	15-5277-004	23	15-5971-014	121	15-7002-044	149
12-1574-224	12	13-0828-034	57	13-5626-401	127	15-5277-004	28	15-5971-014	124	15-7002-044	153
12-1574-234	12	13-0828-034	59	13-5626-401	131	15-5277-004	34	15-5971-014	127	15-7002-044	155
12-3922-004	12	13-0828-034	68	13-5626-401	135	15-5277-004	38	15-5971-014	133	15-7002-044	157
12-3922-004	21	13-0828-034	71	13-5626-401	139	15-5303-004	45	15-5971-014	135	15-7002-044	159
12-3922-004	28	13-0828-034	76	13-5626-401	143	15-5310-104	85	15-5971-014	137	15-7002-044	169
12-3922-014	18	13-0828-034	77	13-5626-401	147	15-5312-104	85	15-5971-014	139	15-7002-054	65
12-3970-584	12	13-0828-034	81	13-5626-401	149	15-5313-004	87	15-5971-014	153	15-7002-054	76
12-3970-584	18	13-0828-034	168	13-5626-401	151	15-5313-004	94	15-5983-024	85	15-7002-054	81
12-3970-584	28	13-0838-054	51	13-5626-401	153	15-5314-104	85	15-5983-024	87	15-7002-054	87
12-6830-094	13	13-0838-054	57	13-5626-401	155	15-5316-004	85	15-5983-024	91	15-7002-054	91
12-6830-094	19	13-0838-054	68	13-5626-401	157	15-5317-004	112	15-5983-024	95	15-7002-054	95
13-0236-004	168	13-0838-054	71	13-5626-401	168	15-5317-014	112	15-5983-024	100	15-7002-054	124
13-0246-004	168	13-0838-054	76	13-5626-631	13	15-5317-024	112	15-5983-024	105	15-7002-054	131
13-0320-004	61	13-0838-054	168	13-5626-631	19	15-5318-104	85	15-5983-024	111	15-7002-054	133
13-0322-281	61	13-1530-004	168	13-5626-631	21	15-5319-004	112	15-5983-024	119	15-7002-054	147
13-0322-281	62	13-1540-004	168	13-5626-631	23	15-5319-304	112	15-5983-024	121	15-7002-054	149
13-0322-281	63	13-1722-001	168	13-5626-631	29	15-5319-904	111	15-5983-024	124	15-7002-054	153
13-0322-281	65	13-1732-001	35	13-5626-631	39	15-5321-004	100	15-5983-024	127	15-7002-054	155
13-0322-281	91	13-1732-001	39	13-5626-631	41	15-5321-104	100	15-5983-024	131	15-7002-054	157
13-0322-281	95	13-1732-001	168	13-5626-631	45	15-5321-204	100	15-5983-024	133	15-7002-054	159
13-0322-281	100	13-5625-981	45	13-5626-631	47	15-5323-004	41	15-5983-024	135	15-7002-054	169
13-0322-281	105	13-5625-981	51	13-5626-631	51	15-5325-004	91	15-5983-024	137	15-7002-064	65
13-0322-281	111	13-5625-981	55	13-5626-631	53	15-5325-101	91	15-5983-024	139	15-7002-064	76

ARTIKELNUMMERN / PART NUMBERS

ARTIKEL NR PART NO	SEITE PAGE	ARTIKEL NR PART NO	SEITE PAGE	ARTIKEL NR PART NO	SEITE PAGE	ARTIKEL NR PART NO	SEITE PAGE	ARTIKEL NR PART NO	SEITE PAGE	ARTIKEL NR PART NO	SEITE PAGE
15-7002-064	107	16-6321-617	13	21-2000-035	113	23-8500-711	77	25-2400-501	36	25-2910-551	27
15-7002-064	124	16-6321-617	19	21-2000-054	113	23-8500-721	77	25-2401-501	36	25-2911-501	27
15-7002-064	133	16-6321-617	29	21-2000-064	113	24-4101-001	46	25-2410-501	37	25-2911-551	27
15-7002-064	169	16-6321-617	41	21-2000-104	113	24-4105-001	46	25-2411-501	37	25-2920-401	40
15-7002-074	65	16-6321-617	55	21-2000-144	113	24-4111-001	46	25-2500-501	36	25-2920-501	27
15-7002-074	76	16-6322-027	21	21-2000-154	113	24-4151-001	46	25-2600-001	31	25-2920-541	27
15-7002-074	107	16-6322-027	47	21-2002-004	113	24-4301-001	46	25-2600-701	31	25-2920-741	27
15-7002-074	169	16-6322-037	39	21-2200-004	104	24-4305-001	46	25-2600-711	31	25-2931-501	27
15-7002-084	169	16-6456-001	147	21-2200-014	104	24-4311-001	46	25-2600-721	31	25-2932-501	27
15-7002-094	169	16-6705-017	13	21-2201-004	104	24-4351-001	46	25-2600-731	31	25-2960-001	25
15-7002-104	169	16-6705-017	47	21-2201-014	104	24-5000-011	58	25-2600-741	31	25-2960-701	25
15-7002-114	169	16-6705-017	59	21-2201-044	104	24-5000-521	58	25-2601-001	31	25-2970-401	27
15-7002-125	133	16-6705-017	85	21-2202-004	104	24-5000-531	58	25-2601-701	31	25-2980-521	25
15-7002-125	147	16-6705-017	139	21-2302-004	100	24-5013-001	58	25-2601-731	31	25-2980-531	27
15-7002-125	153	18-8136-004	35	21-2303-004	100	24-5200-011	58	25-2610-001	33	25-3800-501	22
15-7002-125	155	18-8136-004	39	21-2800-004	115	24-5200-521	58	25-2610-701	33	25-3800-511	22
15-7002-125	157	18-8136-004	47	21-2800-014	116	24-5210-011	58	25-2610-711	33	25-3820-511	22
15-7002-125	169	18-8136-014	94	21-2801-004	116	24-5211-511	58	25-2610-721	33	25-3900-501	22
15-7002-135	133	18-8141-004	18	21-2801-054	116	24-5211-521	58	25-2610-731	33	25-3900-511	22
15-7002-135	147	18-8141-004	29	21-2801-064	116	24-5213-001	58	25-2610-771	33	25-3920-511	22
15-7002-135	153	18-8141-004	41	21-3300-007	91	24-5700-721	56	25-2610-791	33	25-5000-501	20
15-7002-135	155	18-8382-104	81	21-3302-007	91	24-5705-701	56	25-2611-001	33	25-5001-501	20
15-7002-135	157	18-8384-501	76	21-3350-704	91	24-5800-731	56	25-2611-701	33	25-5010-501	20
15-7002-135	169	18-8384-551	76	21-3351-704	91	24-5805-701	56	25-2611-711	33	25-5100-501	20
15-7002-145	169	18-8440-001	47	21-3353-704	91	24-5805-711	56	25-2611-721	33	25-5101-521	20
15-7002-155	169	18-8440-051	47	21-3354-707	91	24-5813-701	56	25-2611-731	33	25-5400-501	20
15-7321-234	100	18-8442-001	47	21-3800-004	47	24-7400-701	52	25-2800-001	24	25-5401-501	20
16-6110-017	43	18-8442-101	47	21-5000-004	115	24-7430-701	52	25-2800-401	40	25-5410-501	20
16-6121-017	43	18-8450-021	59	21-5000-024	115	24-7470-701	52	25-2800-451	24	25-5500-501	20
16-6121-017	73	18-8451-021	59	21-5000-034	115	24-7500-701	52	25-2800-501	24	25-5501-521	20
16-6122-017	73	18-8452-021	59	21-5000-054	115	24-7530-701	52	25-2800-511	24	25-6000-501	14
16-6304-027	29	18-8452-121	59	21-6510-004	85	24-7570-701	52	25-2800-521	24	25-6000-701	14
16-6304-027	39	18-8457-051	57	21-6512-004	85	24-7630-701	52	25-2801-001	24	25-6000-711	14
16-6304-027	41	18-8457-131	57	21-6513-004	85	24-7730-701	52	25-2801-501	24	25-6000-721	14
16-6304-027	47	18-8458-051	57	21-6513-214	85	24-8502-001	54	25-2801-701	24	25-6000-741	14
16-6304-027	55	18-8458-131	57	21-6600-004	104	24-8504-701	54	25-2810-401	40	25-6000-751	14
16-6304-027	95	18-8485-004	55	21-6600-014	104	24-8702-001	54	25-2810-451	26	25-6001-501	14
16-6304-027	117	18-8487-004	55	21-6601-004	104	24-8714-701	54	25-2810-501	26	25-6010-501	14
16-6305-027	21	18-8520-002	38	21-7600-001	73	25-2000-501	36	25-2810-511	26	25-6010-541	14
16-6305-027	39	18-8522-002	34	21-7700-004	112	25-2001-501	36	25-2811-501	26	25-6011-501	14
16-6310-027	19	18-8522-102	34	21-7700-014	112	25-2010-501	37	25-2820-401	40	25-6011-511	16
16-6310-027	21	18-8526-002	28	21-7700-024	112	25-2011-501	37	25-2820-501	26	25-6011-701	16
16-6310-027	29	18-8527-002	28	21-7700-035	112	25-2100-501	36	25-2820-541	26	25-6012-501	16
16-6310-027	41	18-8528-002	28	21-7700-054	112	25-2200-001	30	25-2820-741	26	25-6015-501	16
16-6310-027	43	18-8528-402	41	21-7702-014	112	25-2200-701	30	25-2831-501	26	25-6020-751	16
16-6310-027	47	18-8529-002	28	21-7800-004	113	25-2200-711	30	25-2832-501	26	25-6021-701	16
16-6310-027	55	18-8529-402	41	22-7000-001	76	25-2200-721	30	25-2860-001	24	25-6021-731	16
16-6310-027	59	18-8550-002	21	22-7000-701	74	25-2200-731	30	25-2870-401	26	25-6021-741	16
16-6321-027	76	18-8560-002	18	22-7600-001	73	25-2200-741	30	25-2880-521	24	25-6030-501	14
16-6321-027	81	18-8570-001	12	23-8200-011	78	25-2201-001	30	25-2880-531	26	25-6030-701	14
16-6321-037	13	18-8570-011	12	23-8200-511	78	25-2201-701	30	25-2900-001	25	25-6030-711	14
16-6321-037	19	18-8570-101	12	23-8220-001	78	25-2201-731	30	25-2900-401	40	25-6101-501	14
16-6321-037	21	18-8570-111	12	23-8230-001	78	25-2210-001	32	25-2900-451	25	25-6110-501	16
16-6321-037	29	18-8580-001	43	23-8400-701	77	25-2210-701	32	25-2900-501	25	25-6110-711	16
16-6321-037	39	18-8630-104	135	23-8400-711	77	25-2210-711	32	25-2900-511	25	25-6200-501	14
16-6321-037	41	18-8630-104	137	23-8400-721	77	25-2210-721	32	25-2900-521	25	25-6201-511	14
16-6321-037	43	18-8780-104	81	23-8400-751	74	25-2210-731	32	25-2901-001	25	25-6210-501	16
16-6321-037	47	18-8784-501	76	23-8400-761	74	25-2210-761	32	25-2901-501	25	25-6211-501	16
16-6321-037	55	18-8880-104	81	23-8400-771	74	25-2210-781	32	25-2901-551	25	25-6400-501	15
16-6321-037	57	18-8884-501	76	23-8400-781	74	25-2211-001	32	25-2901-701	25	25-6400-701	15
16-6321-037	59	21-2000-004	113	23-8400-801	74	25-2211-701	32	25-2910-401	40	25-6400-711	15
16-6321-037	76	21-2000-014	113	23-8400-811	74	25-2211-711	32	25-2910-451	27	25-6400-721	15
16-6321-037	81	21-2000-024	113	23-8400-821	74	25-2211-721	32	25-2910-501	26	25-6400-741	15
16-6321-037	147	21-2000-024	113	23-8500-701	77	25-2211-731	32	25-2910-511	27	25-6400-751	15

ARTIKELNUMMERN / PART NUMBERS

ARTIKEL NR PART NO	SEITE PAGE	ARTIKEL NR PART NO	SEITE PAGE	ARTIKEL NR PART NO	SEITE PAGE	ARTIKEL NR PART NO	SEITE PAGE	ARTIKEL NR PART NO	SEITE PAGE	ARTIKEL NR PART NO	SEITE PAGE
25-6401-501	15	25-8050-161	42	31-2214-034	103	31-3302-054	88	31-3366-024	89	31-6604-034	102
25-6410-501	15	25-8100-001	42	31-2214-114	103	31-3302-064	90	31-3366-054	89	31-6604-074	102
25-6410-541	15	25-8100-161	42	31-2214-134	103	31-3302-104	29	31-3366-064	89	31-6604-094	102
25-6411-501	15	25-8100-201	42	31-2264-014	103	31-3302-104	41	31-3366-094	88	31-6604-114	102
25-6411-511	17	25-8100-501	42	31-2264-024	103	31-3303-024	29	31-3367-004	90	31-6607-004	102
25-6411-701	17	25-8250-161	42	31-2264-034	103	31-3303-024	41	31-3404-004	92	31-6607-054	102
25-6412-501	17	25-8300-001	42	31-2267-014	103	31-3303-034	29	31-3404-014	92	31-6614-014	102
25-6415-501	17	25-8300-161	42	31-2267-064	103	31-3303-034	41	31-3404-064	92	31-6614-034	102
25-6420-751	17	25-8300-201	42	31-2267-074	103	31-3303-044	29	31-3404-104	92	31-6614-074	102
25-6421-701	17	25-8300-501	42	31-2267-084	103	31-3303-044	41	31-3404-114	92	31-6614-094	102
25-6421-731	17	26-1200-004	138	31-2304-014	98	31-3303-054	88	31-3404-124	92	31-6664-014	102
25-6421-741	17	26-3000-004	135	31-2304-034	98	31-3303-064	90	31-3404-134	92	31-6664-031	102
25-6430-501	15	26-3010-004	137	31-2304-044	98	31-3303-104	29	31-3404-364	92	31-6667-014	102
25-6430-701	15	27-7600-001	73	31-2304-094	98	31-3303-104	41	31-3405-004	92	31-6700-014	122
25-6430-711	15	27-8000-021	78	31-2304-104	98	31-3304-044	88	31-3405-074	92	31-6700-024	122
25-6501-501	15	27-8001-511	78	31-2307-004	98	31-3304-054	88	31-3406-004	92	31-6700-034	122
25-6501-511	15	27-8100-701	77	31-2307-014	98	31-3304-094	90	31-3406-064	92	31-6700-044	122
25-6510-501	17	27-8100-721	74	31-2307-034	98	31-3304-114	88	31-3407-104	92	31-6700-064	122
25-6510-711	17	27-8400-701	74	31-2364-014	98	31-3304-124	88	31-3407-114	92	31-6704-014	126
25-6600-501	15	28-7600-001	73	31-2364-024	98	31-3304-134	88	31-3604-044	93	31-6704-054	126
25-6601-511	15	28-8000-021	78	31-2364-034	98	31-3304-144	88	31-3604-054	93	31-6704-064	122
25-6610-501	17	28-8001-521	78	31-2364-084	98	31-3305-014	88	31-3605-004	93	31-6704-074	122
25-6611-501	17	28-8100-711	77	31-2364-104	98	31-3305-044	88	31-3606-004	93	31-6704-084	122
25-7000-501	10	28-8100-731	74	31-2364-114	98	31-3305-064	18	31-3608-004	35	31-6704-094	122
25-7000-511	10	28-8400-701	74	31-2364-134	98	31-3305-084	18	31-3608-004	39	31-6704-104	122
25-7000-701	10	28-9100-001	146	31-2364-184	98	31-3305-084	89	31-3608-004	93	31-6704-114	122
25-7000-711	10	29-8410-001	162	31-2364-284	98	31-3305-124	88	31-3608-014	35	31-6704-124	122
25-7000-721	10	29-8410-014	162	31-2364-304	98	31-3305-174	35	31-3608-014	39	31-6704-204	122
25-7000-741	10	31-2000-014	108	31-2364-324	99	31-3305-194	90	31-3608-014	93	31-6707-004	126
25-7001-501	10	31-2000-034	108	31-2364-334	99	31-3305-214	88	31-3704-004	92	31-6707-044	126
25-7001-601	10	31-2004-014	108	31-2364-344	99	31-3305-234	23	31-3704-014	92	31-6707-054	122
25-7008-024	12	31-2004-034	108	31-2364-354	99	31-3305-244	23	31-3707-024	92	31-6800-014	123
25-7008-024	166	31-2004-044	108	31-2367-034	99	31-3305-294	88	31-3707-095	93	31-6804-014	126
25-7020-501	11	31-2004-074	108	31-2367-054	99	31-3306-014	89	31-3707-105	92	31-6804-064	123
25-7020-511	11	31-2007-024	108	31-2367-064	99	31-3306-044	89	31-3707-134	93	31-6804-074	123
25-7020-541	11	31-2007-234	108	31-2464-024	106	31-3306-064	18	31-3707-144	93	31-6804-084	123
25-7020-701	11	31-2007-244	108	31-2464-034	106	31-3306-084	18	31-3792-004	93	31-6804-094	123
25-7020-711	11	31-2007-294	108	31-2804-094	114	31-3306-084	89	31-3793-004	93	31-6807-014	123
25-7020-721	11	31-2007-304	108	31-2804-174	114	31-3306-124	89	31-3804-004	93	31-6807-024	126
25-7020-731	11	31-2007-334	108	31-2804-204	117	31-3306-174	35	31-3804-014	93	31-6900-014	99
25-7021-511	11	31-2007-344	108	31-2814-004	114	31-3306-194	90	31-3805-004	93	31-6904-014	99
25-7030-711	10	31-2064-014	108	31-2814-024	114	31-3306-214	89	31-3805-024	93	31-6904-034	99
25-7030-721	10	31-2064-034	108	31-2864-004	114	31-3306-234	23	31-3806-004	93	31-6904-054	99
25-7400-501	10	31-2064-124	108	31-2864-034	114	31-3306-244	23	31-3806-024	93	31-6904-124	99
25-7400-511	10	31-2064-214	108	31-3100-004	86	31-3306-294	89	31-5004-014	114	31-6904-164	99
25-7400-701	10	31-2064-234	109	31-3102-024	13	31-3307-014	90	31-5004-094	114	31-6907-034	99
25-7400-711	10	31-2064-414	109	31-3102-024	86	31-3307-024	90	31-5004-104	114	31-6964-004	99
25-7400-721	10	31-2064-434	109	31-3102-034	86	31-3307-044	90	31-5004-154	114	31-7100-004	118
25-7400-741	10	31-2064-714	109	31-3103-024	13	31-3307-104	90	31-6004-074	120	31-7100-004	118
25-7401-531	10	31-2064-734	109	31-3103-024	86	31-3307-134	90	31-6004-094	120	31-7100-014	118
25-7401-601	10	31-2064-774	109	31-3103-034	86	31-3307-194	90	31-6204-084	120	31-7100-014	118
25-7420-501	11	31-2067-084	109	31-3104-004	86	31-3307-224	90	31-6204-104	120	31-7100-034	118
25-7420-511	11	31-2067-094	109	31-3104-014	86	31-3360-004	90	31-6404-014	99	31-7100-034	118
25-7420-541	11	31-2067-104	109	31-3105-004	86	31-3362-004	89	31-6404-094	99	31-7100-054	118
25-7420-551	11	31-2067-694	109	31-3106-004	86	31-3362-104	89	31-6404-124	99	31-7100-054	118
25-7420-701	11	31-2104-014	109	31-3300-074	88	31-3363-004	89	31-6504-084	84	31-7100-064	118
25-7420-711	11	31-2104-034	109	31-3300-244	90	31-3363-104	89	31-6504-104	84	31-7100-064	118
25-7420-721	11	31-2164-014	109	31-3300-374	90	31-3364-004	90	31-6504-134	84	31-7100-104	118
25-7420-731	11	31-2164-034	109	31-3302-024	29	31-3364-024	89	31-6504-174	84	31-7100-104	118
25-7420-751	11	31-2204-014	103	31-3302-024	41	31-3364-054	89	31-6564-064	84	31-7100-114	118
25-7420-761	11	31-2204-154	105	31-3302-034	29	31-3365-014	89	31-6564-074	84	31-7100-114	118
25-7421-521	11	31-2214-004	103	31-3302-034	41	31-3365-054	89	31-6564-144	84	31-7104-004	118
25-7430-711	10	31-2214-014	103	31-3302-044	29	31-3365-064	89	31-6564-154	84	31-7104-004	118
25-7430-721	10	31-2214-024	103	31-3302-044	41	31-3365-094	88	31-6604-014	102	31-7104-014	118

ARTIKELNUMMERN / PART NUMBERS

ARTIKEL NR PART NO	SEITE PAGE	ARTIKEL NR PART NO	SEITE PAGE	ARTIKEL NR PART NO	SEITE PAGE	ARTIKEL NR PART NO	SEITE PAGE	ARTIKEL NR PART NO	SEITE PAGE	ARTIKEL NR PART NO	SEITE PAGE
31-7104-014	118	31-9221-011	64	34-8505-001	54	36-3003-014	134	38-7600-701	73	65-6502-014	61
31-7104-024	118	31-9230-001	62	34-8605-001	54	36-3004-014	134	38-8000-031	79	68-5000-014	100
31-7104-024	118	31-9231-001	62	34-8702-001	54	36-3004-024	134	38-8000-051	79	68-5000-014	105
31-7104-034	118	31-9231-201	62	34-8706-001	54	36-3004-034	134	38-8000-061	79	68-5000-014	111
31-7104-034	118	31-9231-211	62	34-8806-001	54	36-3004-044	134	38-8007-131	79	68-5000-014	117
31-7104-054	118	32-7000-701	74	35-0201-001	50	36-3004-054	134	38-8007-141	79	68-5000-034	100
31-7104-054	118	32-7200-001	60	35-0201-011	50	36-3004-084	136	38-8007-151	79	68-5000-034	105
31-7107-014	118	32-7207-001	60	35-0201-021	50	36-3004-184	136	38-8107-061	75	68-5000-034	111
31-7107-014	118	32-7600-001	72	35-0201-031	50	36-3007-084	134	38-8200-001	148	68-5000-034	117
31-7110-004	118	32-7600-701	73	35-0201-041	50	36-3007-254	134	38-8204-011	152	68-5000-574	85
31-7110-004	118	33-7200-001	60	35-0202-001	50	36-3007-264	134	38-8207-001	148	68-5000-574	135
31-7204-014	118	33-7200-011	60	35-0202-011	50	36-3007-284	134	38-8207-011	148	68-5000-574	137
31-7204-014	118	33-7207-041	60	35-0202-021	50	36-3007-394	134	38-8220-001	152	68-5000-574	139
31-7204-024	118	33-7207-051	60	35-0202-031	50	36-3007-464	134	38-8220-011	152	68-5000-604	85
31-7204-024	118	33-8100-001	66	35-0202-041	50	36-3007-574	134	38-8220-021	152	68-5000-604	135
31-7204-044	118	33-8100-101	66	35-0203-001	48	36-3600-004	132	38-8221-001	150	68-5000-604	137
31-7204-044	118	33-8100-201	69	35-0203-011	48	36-3600-014	132	38-8221-101	150	68-5000-624	135
31-7207-014	118	33-8100-501	66	35-0203-021	48	36-3600-024	132	38-8226-001	152	68-5000-624	137
31-7207-014	118	33-8100-601	66	35-0203-031	48	36-3600-044	132	38-8226-101	152	68-5000-634	85
31-7210-004	118	33-8100-701	69	35-0203-041	48	36-3604-004	132	38-8226-111	152	68-5000-634	135
31-7210-004	118	33-8107-021	69	35-0203-051	48	36-3604-014	132	38-8227-001	150	68-5000-634	137
31-7400-004	123	33-8107-031	69	35-0203-061	48	36-3604-024	132	38-8227-021	152	68-5018-004	111
31-7400-014	123	33-8107-041	66	35-0203-071	48	36-3607-004	132	38-8227-101	150	68-5018-024	111
31-7600-001	72	33-8107-051	66	35-0203-081	48	36-3607-014	132	38-8407-001	75	75-0300-001	18
31-7600-701	73	33-8180-001	66	35-0203-091	48	36-3607-024	132	38-9000-001	146	75-0300-001	166
31-7704-014	110	33-8205-031	78	35-0203-101	48	36-3607-034	132	38-9007-011	146	75-0309-001	23
31-7704-034	110	33-8205-081	78	35-0203-111	48	36-3607-074	132	38-9010-001	146	75-0309-001	166
31-7704-054	110	33-8205-101	78	35-0203-121	48	36-3607-094	132	38-9100-001	146	75-0310-001	166
31-7704-094	110	33-8206-031	78	35-0203-131	48	36-3690-004	132	38-9100-081	146	75-0314-001	166
31-7704-124	110	33-8206-091	78	35-0203-141	48	36-3690-014	132	38-9107-011	146	75-0324-001	166
31-7707-034	110	33-8206-101	78	35-0204-001	49	36-3690-024	132	38-9207-001	62	76-5132-011	166
31-7707-104	110	33-8400-011	74	35-0204-011	49	36-3690-034	132	38-9207-011	64	76-9027-001	63
31-7707-114	110	33-8402-031	74	35-0204-021	49	36-3690-044	132	38-9207-021	62	76-9027-001	65
31-7707-214	110	33-8403-031	74	35-0204-031	49	36-3804-004	130	38-9220-001	64	76-9028-001	63
31-7764-014	110	33-8403-041	75	35-0204-041	49	36-3804-014	130	38-9220-011	64	76-9028-001	65
31-7764-214	110	33-8405-081	75	35-0204-051	49	36-3805-004	130	38-9230-001	62	87-1364-001	107
31-7764-234	110	33-8405-091	75	35-0204-061	49	36-3806-004	130	38-9231-001	62	87-1366-011	107
31-7804-014	110	33-8405-101	75	35-0204-071	49	36-3807-004	130	38-9237-001	62	87-3047-021	80
31-7804-054	110	33-8406-081	75	35-0204-081	49	36-3810-004	130	39-6400-011	156	87-3048-021	80
31-7804-094	110	33-8406-091	75	35-0204-091	49	36-3864-004	130	39-6400-021	154	87-3067-001	80
31-7804-124	110	33-8406-101	75	35-0204-101	49	36-3864-014	130	39-6400-031	156	87-3068-001	80
31-7804-144	110	33-8407-014	75	35-0204-111	49	36-3865-004	130	39-6400-041	156	87-3079-001	75
31-8900-024	142	33-9200-001	67	35-0204-121	49	36-3867-004	130	39-6407-001	156	87-3080-001	75
31-8900-044	142	33-9200-011	67	35-0204-131	49	36-3867-014	130	39-6407-011	156	87-3081-001	80
31-8907-004	142	33-9200-021	67	35-0204-141	49	36-3867-024	130	39-6800-011	154	87-3082-001	80
31-8907-014	142	33-9200-201	70	35-0301-001	44	37-7200-001	60	39-6801-001	154		
31-8910-014	142	33-9200-301	70	35-0301-011	44	37-7207-001	60	39-6807-001	154		
31-8910-024	142	33-9200-501	67	35-0301-021	44	37-7600-001	72	39-7000-001	75		
31-8920-001	64	33-9200-511	67	35-0301-041	44	37-7600-701	73	39-7007-001	75		
31-8927-001	64	33-9200-701	70	35-0302-001	44	37-8000-041	79	39-8404-001	162		
31-9000-054	142	33-9200-711	70	35-0302-011	44	37-8000-061	79	39-8409-001	162		
31-9007-014	142	33-9207-051	67	35-0302-021	44	37-8007-131	79	39-8700-011	163		
31-9207-001	62	33-9207-061	70	35-0302-041	44	37-8007-161	79	39-8704-001	163		
31-9207-011	62	33-9207-071	70	35-2103-051	37	37-8007-191	79	39-8704-011	163		
31-9207-021	62	33-9207-081	67	35-2103-061	36	37-8400-001	75	39-8707-001	163		
31-9207-031	62	33-9207-091	70	35-2502-051	37	37-8407-001	75	39-8900-001	160		
31-9207-041	64	33-9280-001	67	35-2502-071	36	37-9207-001	62	39-8900-051	160		
31-9207-051	64	34-5703-001	56	35-5103-011	20	37-9207-011	64	39-8900-101	160		
31-9207-061	62	34-5703-011	56	35-5502-011	20	37-9220-001	64	39-8900-151	160		
31-9207-071	62	34-5705-001	56	3-5626-401	133	37-9220-011	64	39-8900-201	160		
31-9207-081	62	34-5802-001	56	36-1204-034	138	37-9230-001	62	39-8900-251	160		
31-9220-001	64	34-5802-011	56	36-1207-004	138	38-7200-001	60	39-8900-301	161		
31-9220-011	64	34-5806-001	56	36-3000-134	134	38-7207-001	60	39-8900-351	161		
31-9221-001	64	34-8503-001	54	36-3002-014	134	38-7600-001	72	39-8900-401	161		

PIKTOGRAMM ÜBERSICHT / PICTOGRAM OVERVIEW

PIKTOGRAMM ÜBERSICHT	
	Verpackungseinheit
	x Stück pro Karton
	links
	rechts
	Leuchtmittel
	Volt
	Umrissarm
	Glühbirne
	LED
	Blinklicht
	Blinklicht rechts
	Blinklicht links
	dynamischer Blinker rechts
	dynamischer Blinker links
	mit integriertem Blink- LCG
	mit integriertem LCG2
	Rücklicht
	Bremslicht
	Nebelschlusslicht
	Rückfahrlicht
	Dreieckrückstrahler
	ohne Dreieckrückstrahler
	Positionslicht
	Seitenmarkierungslicht
	ohne Seitenmarkierungs- licht
	Seitenmarkierungslicht + Reflektor
	Begrenzungslicht hinten

PICTOGRAM OVERVIEW	
	Packaging unit
	x pieces per box
	Left
	Right
	Light source
	Volt
	End Outline marker
	Bulb
	LED
	Direction indicator
	Direction indicator right
	Direction indicator left
	Progressive direction indicator right
	Progressive direction indicator left
	With integrated direction indicator LCG
	With integrated LCG2
	Tail light
	Stop light
	Fog light
	Reverse light
	Triangle reflector
	Without triangle reflector
	Position light
	Sidemarker light
	Without sidemarker light
	Sidemarker light + reflector
	Rear position light

PIKTOGRAMM ÜBERSICHT / PICTOGRAM OVERVIEW

LEGENDA			
	Pezzi per confezione		Luce di posizione anteriore
	Pezzi per scatola		Rosso, bianco, arancione
	Sinistro		Rosso, bianco
	Destro		Rosso
	Tipo di luce		Bianco
	Volt		Luce d'ingombro
	Luce d'ingombro		Catadiottro rosso
	Lampadina		Catadiottro arancione
	LED		Catadiottro bianco
	Freccia		Faro da lavoro
	Freccia destra		Luce targa
	Freccia sinistra		Segnalatore acustico per retromarcia
	Freccia progressiva destra		Maschio
	Freccia progressiva sinistra		Femmina
	Con LCG per freccia		Flood
	Con LCG per tutte le funzioni		Spot
	Luce di posizione		Montaggio orizzontale
	Stop		Montaggio verticale
	Retronebbia		Montaggio a 360°
	Retromarcia		Lumen
	Catadiottro triangolare		Watt
	Senza catadiottro triangolare		ADR Zone 2
	Luce di posizione destra		IPXX
	Luce laterale		
	Senza luce laterale		
	Luce laterale + catadiottro		
	Luce di posizione posteriore		

LÉGENDE DES PICTOGRAMMES			
	Conditionnement		Feu de gabarit avant
	X pièces par carton		Rouge, blanc, orange
	Gauche		Rouge, blanc
	Droit		Rouge
	Source lumineuse		Blanc
	Voltage		Feu d'encombrement
	Feu sur antenne		Catadioptr rouge
	Ampoule		Catadioptr orange
	LED		Catadioptr blanc
	Clignotant		Phare de travail
	Clignotant droit		Eclaireur de plaque
	Clignotant gauche		Alarme de recul
	Clignotant à défilement droit		Mâle
	Clignotant à défilement gauche		Femelle
	Avec LCG clignotant intégré		Large
	Avec LCG toutes fonctions intégré		Etroit
	Feu de position		Montage horizontal
	Feu de stop		Montage vertical
	Feu de brouillard		Montage à 360° possible
	Feu de recul		... Lumen
	Catadioptr triangulaire		... Watt
	Sans catadioptr triangulaire		ADR Zone 2
	Feu de gabarit		Classe IPxx
	Feu latéral orange		
	Sans feu latéral orange		
	Feu latéral orange+catadioptr		
	Feu de gabarit arrière		

PIKTOGRAMM ÜBERSICHT / PICTOGRAM OVERVIEW

DESCRIPCIÓN DE PICTOGRAMA	
	Unidad de embalaje
	x piezas por caja
	Izquierdo
	derecho
	Tipo de luz
	Voltaje
	Cuerno final de linea
	Lámpara
	Led
	Indicador de dirección
	Indicador de dirección-derecho
	Indicador de dirección izquierdo
	Indicador de dirección progresivo derecho
	Indicador de dirección progresivo izquierdo
	Con indicador de dirección integrado en LCG
	Con LCG integrado (todas las funciones)
	Luz de gálibo
	Luz de Freno
	Luz Antiniebla
	Luz Marcha atrás
	Triángulo reflectante
	Sin Triángulo reflectante
	Luz de posición
	Luz lateral
	Sin Luz lateral
	Luz lateral + reflectante
	Gálibo trasero
	Gálibo delantero
	rojo, blanco, ambar
	rojo, blanco
	rojo
	blanco
	Cuerno final de linea
	Reflectante rojo
	Reflectante ambar
	Reflectante blanco
	Faro de trabajo
	Luz de matrícula
	Retro-alarma
	Macho
	Hembra
	Amplia
	Larga
	Montaje Horizontal
	Montaje Vertical
	Montaje 360°
	Lumen
	Wattios
	Zona 2 ADR
	Tipo IPxx

LEGENDA	
	Jednostka miary
	x sztuk w kartonie
	Lewa
	Prawa
	ródło światła
	Napięcie
	Obrys gumowy narożny
	arówka
	LED
	Kierunkowskaz
	Prawy kierunkowskaz
	Lewy kierunkowskaz
	Prawy kierunkowskaz progresywny
	Lewy kierunkowskaz progresywny
	Ze zintegrowanym LCD dla kierunkowskazu
	Ze zintegrowanym LCD dla wszystkich funkcji
	wiatro pozycyjne tylne
	Stop
	wiatro przeciwmgłowe
	Wsteczny
	Trójkąt z odblaskiem
	Trójkąt bez odblasku
	wiatro pozycyjne
	wiatro obrysowe boczne
	Bez wiatro obrysowego boczno
	wiatro obrysowe boczne + odblask
	wiatro pozycyjne tylne
	wiatro pozycyjne przednie
	Czerwone, Białe, Pomarańczowe
	Czerwone, Białe
	Czerwone
	Białe
	Obrys gumowy narożny
	Odblask czerwony
	Odblask pomarańczowy
	Odblask biały
	Lampa robocza
	Oświetlenie tablicy rejestracyjnej
	Dźwiękowy sygnalizator cofania
	Męska
	żeńskie
	wiatro rozproszone
	wiatro skupione
	Montaż poziomy
	Montaż pionowy
	Montaż 360°
	Lumen
	Watt
	Strefa 2 ADR
	Klasa IPXX

PIKTOGRAMM ÜBERSICHT / PICTOGRAM OVERVIEW

PIKTOGRAM ÖZETİ			
	Paketleme Sayısı		Pozisyon Lamba - Beyaz
	Her kutuda x adet		Kırmızı, Beyaz, Sarı
	Sol		Kırmızı, Beyaz
	Sağ		Kırmızı
	Lamba		Beyaz
	Voltaj		Boşuz Lamba
	Boşuz Lamba		Kırmızı Reflektör
	Ampul		Sarı Reflektör
	LED		Beyaz Reflektör
	Sinyal Lamba		Çalışma Lambası
	Sinyal Lamba Sağ		Plaka Lambası
	Sinyal Lamba Sol		Geri Vites İkaz Sireni
	Progresif Sinyal Lamba Sağ		Erkek
	Progresif Sinyal Lamba Sol		Dişi
	LCG'li sinyal lamba		Geniş Açık
	LCG'li (Bütün Fonksiyonlar)		Spot
	Park Lamba		Yatay Montaj
	Fren Lamba		Dikey Montaj
	Sis Lamba		360° Uçulanabilir
	Geri Vites Lamba		... Lumen
	Üçgen Reflektör		... Watt
	Üçgen Reflektörsüz		ADR Zone 2
	Pozisyon Lamba		IP Sınıfı
	Yan Park Lamba		
	Yan Park Lambasız		
	Yan Park Lamba+Reflektör		
	Gabari Lamba - Kırmızı		

KUVIEN SELITYS			
	Pakkauskoko		Etuäärivalo
	X per laatikko		Punainen, valkoinen, keltainen
	Vasen		Punainen, valkoinen, keltainen
	Oikea		Punainen
	Valolähde		Valkoinen
	Voltia		Kumivarsivalo
	Kumivarsivalo		Heijastin punainen
	Polttimo		Heijastin keltainen
	LED		Heijastin valkoinen
	Vilkku		Työvalo
	Vilkku oikea		Rekisterikilven valo
	Vilkku vasen		Peruutushälytін
	Progressiivinen vilkku oikea		Uros
	Progressiivinen vilkku vasen		Naaras
	LCG:llä vilkkua varten		Leveä valokuvio (flood)
	LCG:llä kaikkia toimintoja varten		Kapea valokuvio (spot)
	Parkkivalo		Vaaka-asennus
	Jarruvalo		Pystyasennus
	Sumuvalo		360° asennus mahdollinen
	Peruutusvalo		... Lumenia
	Heijastinkolmio		... Wattia
	Ilman heijastavaa kolmiota		ADR Zone 2
	Äärivalo		IP xx luokitus
	Sivuäärivalo		
	Ilman sivuäärivaloa		
	Sivuäärivalo + heijastin		
	Takaäärivalo		

PIKTOGRAMM ÜBERSICHT / PICTOGRAM OVERVIEW

ÖVERSIKT	
	Förpacknings-storlek
	x per kartong
	Vänster
	Höger
	Ljuskälla
	Volt
	Breddmarkering
	Glödlampa
LED	LED
	Blinkers
	Blinkers Höger
	Blinkers Vänster
	Progressiv blinkers höger
	Progressiv blinkers vänster
	Med integrerad LCG för blinkers
	Med integrerad LCG för alla funktioner
	Parkeringsljus
	Bromsljus
	Dimljus
	Backljus
	Reflextriangel
	Utan reflextriangel
	Positionsljus
	Sidomarkeringsljus
	Utan Sidomarkeringsljus
	Sidomarkering + reflex
	Bakre positionsljus
	Främre positionsljus
	Röd, vit, gul
	Röd, vit
	Röd
	Vit
	Breddmarkering
	Reflex röd
	Reflex gul
	Reflex vit
	Arbetsbelysning
	Nummerplåtsbelysning
	Backvarnare
	Hane
	Hona
	Bred ljusbild (flood)
	Smal ljusbild (spot)
	Horisontell montering
	Vertikal montering
	360° montering möjlig
	...Lumen
	...Watt
	ADR Zone 2
	IP xx Klass

PICTOGRAM OVERZICHT	
	Verpakkingseenheid
	x stuks per doos
	links
	rechts
	lichtbron
	volt
	Pendelarm
	bollamp
LED	LED
	Knipperlicht
	Knipperlicht rechts
	Knipperlicht links
	dynamisch knipperlicht rechts
	dynamisch knipperlicht links
	met geïntegreerde knip- perlicht LCG
	met geïntegreerde LCG (alle functies)
	Achterlicht
	Remlicht
	Mistlicht
	Achteruitrijlicht
	Driehoek reflector
	zonder driehoek re- flector
	Positielicht
	Zijmarkeringslicht
	zonder zijmarkeringlicht
	Zijmarkeringslicht + reflector
	Positielicht achter
	Positielicht voor
	rood, wit, oranje
	rood, wit
	rood
	wit
	markeringslicht
	Reflector rood
	Reflector geel
	Reflector wit
	Werklamp
	Kentekenlamp
	Achteruitrij alarm
	mannelijk
	vrouwelijk
	Flood
	Spot
	horizontale montage
	verticale montage
	360° montage mogelijk
	Lumen
	Watt
	ADR Zone 2
	IPxx Klasse

THE ART OF LIGHTS

Aspöck Systems GmbH

Enzing 4 | 4722 Peuerbach | AUSTRIA
Phone.: +43 72 76 / 26 70-0 | Fax: DW 1199
E-Mail: office@aspoeck.com | www.aspoeck.com



Management System
ISO 9001:2008
VDA 6.1

www.tuv.com
ID: 9105017409

10-0360-037
ASP_SPARE_01_DE/E_052017
Printing errors, technical changes
as well as picture changes reserved.
© Aspöck Systems GmbH

www.aspoeck.com

UNITED KINGDOM, EIRE

Aspöck UK Ltd.
Unit 19, Stansted Distribution Centre
Great Hallingbury
Bishops Stortford, Herts
GB-CM22 7DG
Tel.: +44 1279 655 220
Fax: +44 1279 505 869
E-Mail: sales@aspoeck.co.uk
www.aspoeck.co.uk

FRANCE, ALGERIA, MOROCCO, TUNISIA

Aspöck France S.A.S.
1210 Avenue de Lossburg
Zone Industrielle Sud
F-69480 Anse
Tel.: +33 437 5508 65
Fax: +33 437 5508 97
E-Mail: office@aspoeck.fr
www.aspoeck.com

SPAIN, PORTUGAL

Aspöck Iberica
Via Sergia, 32 Nave N° 2
Poligono Industrial
"Les Hortes del Cami Ral"
E-08302 Mataro (Barcelona)
Tel.: +34 937 598 039
Fax: +34 937 501 033
E-Mail: aspock@aspock.com
www.aspock.com

SWEDEN, FINLAND, NORWAY, DENMARK ESTONIA

Aspöck Norden AB
Birger Svenssons väg 16E
SE-432 40 Varberg
Tel.: +46 340 483 870
Fax: +46 340 483 879
E-Mail: order@aspoeck-norden.se
www.aspoeck.com

ITALY

PAGG Aspöck srl
Via Legnano, 8
I-20835 Muggiò (MB)
Tel.: +39 039 278 5255
Fax: +39 039 278 9582
E-Mail: info@aspoeck.it

BRAZIL

Aspock do Brasil Ltda.
Estrada RS 122 km 88,5 S/N
Bairro São Gotardo
Flores da Cunha-RS
CEP 95270-000
Tel.: +55 54 3039-5400
E-Mail: contato@aspock.com.br
www.aspock.com

POLAND, LITHUANIA, LATVIA

Aspöck Systems Polska Sp.z.o.o.
ul. Byczyńska 10
46-320 Praszka
Tel.: +48 34 3430 600
Fax: +48 34 3430 609
E-Mail: office.poland@aspoeck.com
www.aspoeck.com

TURKEY, MIDDLE EAST

Aspöck Aydınlatma Sist. Tic. Ltd. Şti.
Feneryolu Mah. Yıldırım Sok.
No 20/B 34724
Kadıköy / Istanbul
Turkey
Tel.: +90 216 510 54 00
E-Mail: infoturkey@aspock.com
www.aspock.com

GERMANY

Suer GmbH & Co KG
Handelsstraße 5
D-42929 Wermelskirchen
Tel.: +49 2196 946 0
Fax: +49 2196 946 100
E-Mail: info@suer.de

GERMANY

Hofmeister & Meincke
Carsten-Dressler-Straße 6
D-28279 Bremen
Tel.: +49 421 8405 296
Fax: +49 421 8405 201
E-Mail: bremen@hofmei.de

AUSTRIA, HUNGARY, CROATIA, CZECH REPUBLIC,

Ing. A. F. Baeder Ges.m.b.H.
Leopoldgasse 13-17
A-1230 Wien
Tel.: +43 1 865 16 40
Fax: +43 1 869 22 12
E-Mail: sales@baeder-automotive.com

AUSTRIA (ONLY 12V)

Knott Handelsges.m.b.H.
Rennweg 79-81
A-1030 Wien
Tel.: +43 1 714 22 22
Fax: +43 1 714 22 33
E-Mail: info@knott.at

SWITZERLAND

AGL AG für Lastwagenzubehöre
Müslistrasse 43
CH-8957 Spreitenbach
Tel.: +41 41 348 04 80
Fax: +41 41 340 31 79
E-Mail: info@agl.ch

NETHERLAND, BELGIUM,

Frits Dijk International
Collse Heide 64
NL-5674 VN Nuenen
Tel.: +31 40 2831815
Fax: +31 40 2838717
E-Mail: info@fritsdijk.nl

SERBIA, ROMANIA, BULGARIA, SLOVAKIA

Ing. A. F. Baeder Ges.m.b.H.
Leopoldgasse 13-17
A-1230 Wien
Tel.: +43 1 865 16 40
Fax: +43 1 869 22 12
E-Mail: sales@baeder-automotive.com

MONTENEGRO, SLOVENIA, BOSNIA AND HERZEGOVINA

Ing. A. F. Baeder Ges.m.b.H.
Leopoldgasse 13-17
A-1230 Wien
Tel.: +43 1 865 16 40
Fax: +43 1 869 22 12
E-Mail: sales@baeder-automotive.com

ISRAEL

M.N. Systems
4 Beith Harishonim st
P.O.B 12186
Industrial Park Emek Hefer 38777,
Israel
Tel.: +97 24 6220 111
Fax: +97 24 6220 808
E-Mail: info@mnsys.co.il

EAST ASIA

JM Company
30, Heungdo-ro 415 beongil
Doekyang-gu, Goyang-si, Gyeonggi-do
412-020, S. Korea
Tel.: +82 31 902 7670
Fax: +82 31 902 7671

RUSSIA, KYRGYZSTAN, MONGOLIA, BELARUS, KAZAKHSTAN

STAT Ltd
141580, Moscow region,
Solnechnogorsky district,
Dubrovki village, Aeroportovskaya str.,
bldg.2, Sherland BC
Tel.: + 7 (495) 739-03-47
email: info@stat-parts.ru
www.stat-parts.ru